

RaceON

BRAKE PADS CATALOGUE

RaceON

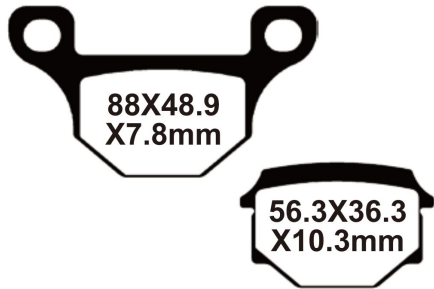

RMO-0001			
APPLICATION			
SUZUKI	GN125	F	83-94
SUZUKI	GS125	F	82-90
SUZUKI	GS125ESD	F	
SUZUKI	INTRUDER 125	F	

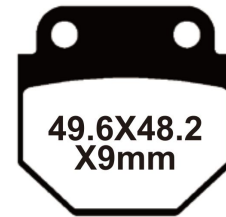

RMO-0004			
APPLICATION			
BETTER	BT 125-20	F	06-09
KYMCO	CK 125 Pulsar	F	99-00

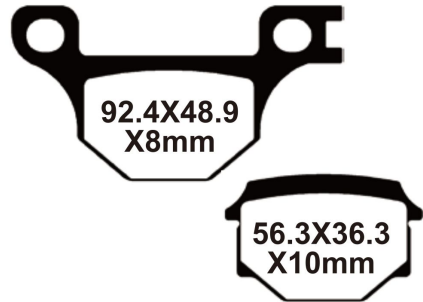

RMO-0001A			
APPLICATION			
	H-3A	F	



RMO-0005			
RMK-0005			
APPLICATION			
HONDA	CM125	F	
HONDA	VT600	F	
HONDA	HORNET 600	F	



RMO-0002			
APPLICATION			
HONDA	CB125	F	83-89
HONDA	CBX 125/250	F	84-
HONDA	CBR 400/500/600/750	F	84-90
HONDA	VF 750	F	82-84

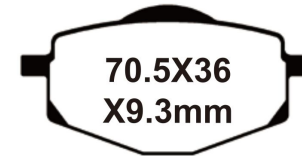

RMO-0006			
APPLICATION			
YAMAHA	YBR 125 ED/ESD	F	07-13
YAMAHA	YJ 125 S/T/V/W/X Vino	F	04-09
YAMAHA	DT 125 LC/R	F	85-86
YAMAHA	TDR 125R 93	R	85-00
YAMAHA	XT225	F	92-98



RMO-0003			
RMK-0003			
APPLICATION			
YAMAHA	FZ6	F	04-06
YAMAHA	FZ6R	F	09-17
YAMAHA	XV 250 VIRAGO all models	F	95-07
YAMAHA	XVS 1300 V-Star	F	07-14

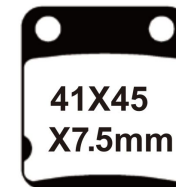

RMO-0007			
APPLICATION			
HONDA	GL145	F	
HONDA	CG 125 ES12/ES2/3/4	R	01-04
SUZUKI	DR125/ES/200/ES	F	86-96
YCF	PIT BIKE	R	
YAMAHA	ATV YFM 125	F	11-13
KAWASAKI	ATV KVF 360	F	03-12
SUZUKI	ATV LT-F 250	F	02-14



RMO-0007A			
APPLICATION			
KAWASAKI ATV	KVF 360	F	03-12
YAMAHA ATV	YMF 250	F	07-09
SUZUKI ATV	LT-F 250	F	02-14



RMO-0011			
APPLICATION			
KYMCO	GY6-125	F	
SUZUKI	CS125/SCOOTER	F	
CPI	Oliver City	F	05-09



RMO-0008			
APPLICATION			
YAMAHA	Lander Xtz 125 250	F	
SUZUKI	Yes Xtz 750	F	
KAWASAKI ATV	KVF 750	F(right)	12-15
SUZUKI ATV	LT-R 450	F(right)	06-11
YAMAHA ATV	YFZ 450	F(right)	09-15



RMO-0012			
APPLICATION			
KYMCO	GY6-125T; GY125A	F	
HONDA	SK50M DIO	F	97-98
PIAGGIO VESPA	MP3 Touring	F	07-14
SYM	Super Fancy 50	F	96-02
SYM	City Hopper 50	F	99-02



RMO-0009			
APPLICATION			
YAMAHA	YBR 125 ED	F	02-08
YAMAHA	YS 250 Fazer	F	06-15
HONDA	CBX 250 Twister	F	01-08
HONDA	CB 300R	F	09-15
KAWASAKI ATV	KVF 750	F(Left)	12-15
YAMAHA ATV	YFZ 450	F(Left)	09-15
SUZUKI ATV	LT-F 450	F(Left)	06-11
APRILIA	SR GT125 SPORT	R	



RMO-0013			
APPLICATION			
APRILIA	RS125	R	
SUZUKI	AG100	F	91-94
SUZUKI	AN125HK	F	06-08
SUZUKI	AH100	F	91
KAWASAKI	KDX 125	F	90-97
KAWASAKI	KMX 125	F	86
POLARIS ATV	200 Phoenix	F	05-09



RMO-0010			
APPLICATION			
HONDA	WY-125	F	



RMO-0014			
APPLICATION			
KAWASAKI	KLX125L	F	03-06
YAMAHA	Cuxi	F	12-14
SUZUKI	DR-Z125L	F	03-14
SUZUKI	AN125	F	94-05
SUZUKI	RM80	F	96-01
SUZUKI	AG100	F	95-04

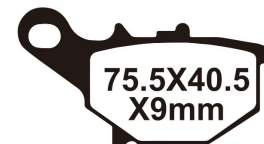

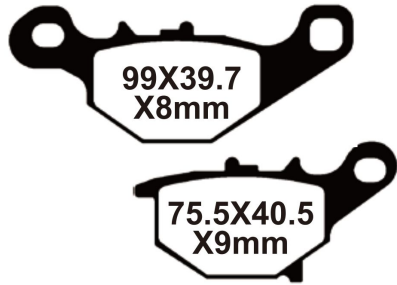

RMO-0014B

APPLICATION			
SUZUKI	RM85	R	05-13
SUZUKI	RM85L	R	05-13



RMO-0018

APPLICATION			
AKT	AKT110/SMART-AKT 125/125SL	F	
HONDA	NSR 50/MBX 50	F	88-92
HONDA	CBX 125/CBX 250	F	85-87
HONDA	XRM/WAVE110	F	
HONDA	YES 125/XTZ125	F	
AJP		F	
YCF	PIT BIKE	F	

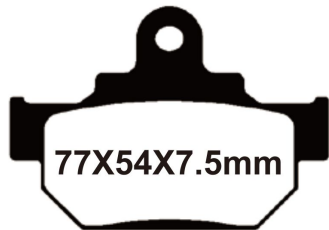

RMO-0015

APPLICATION			
SUZUKI	GZ 125/GZ 250	F	98-10
SUZUKI	VL250	F	00-07
SUZUKI	DR600S	F	85-88
MAICO	GP250/GP400/GM500	F	87



RMO-0018A

APPLICATION			
AKT	110	F	
AKT	125	F	



RMO-0016

APPLICATION			
HONDA	WY-100	F	



RMO-0018A

APPLICATION			
AKT	GT250/GV250/GT650	F	11
HYOSUNG	GT125	F	01-14
KYMCO	Spike 125	F	08-13
HONDA	CBX125	F	94-92
HONDA	NSR80	F	88-92



RMO-0017

APPLICATION			
HONDA	XR650 L	R	93-14
HONDA	NSR50	R	93-99
HONDA	DREAM 50 R(CB 50)	R	04
KAWASAKI	KLX250	R	09-14
SUZUKI	RM125/250	R	96-05
SUZUKI	DR-Z400	R	00-14



RMO-0019

APPLICATION			
Chinese electric scooter Friction compound is smaller than that of YL-F019			



RMO-0020			
APPLICATION			
HONDA	CR250R/CR500R	F	84-86
HONDA	XL600R	F	83-87
HONDA	XR250R	F	84-87
YAMAHA ATV	YFZ 450	R	09-15
HONDA ATV	TRX 250R	F	86-89



RMO-0024			
APPLICATION			
YAMAHA	RXS 115	F	94-97
YAMAHA	RX-Z	F	00-05
YAMAHA	XT600	F	87-89

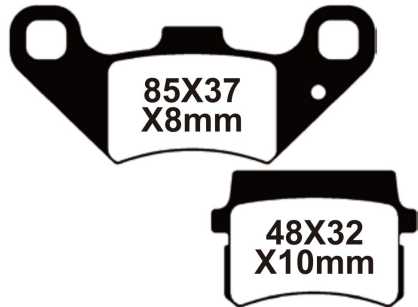

RMO-0021			
APPLICATION			
ADLY	Interceptor 300 Quad	F	
EXPLORER	Ranger 300	F	08-09
QUADZILLA	XRV 250	F	06-07
QUADZILLA	RL 300	F	07-08
MH Contd	RYZ 50	F	13-14

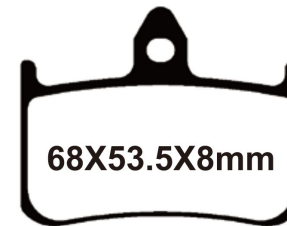

RMO-0025			
APPLICATION			
HONDA	CB 1000	F	94-95
HONDA	CBR 900 RR	F	93-97
HONDA	Super Hawk 1000	F	00-05
HONDA	VFR750 R	F	90



RMO-0022			
APPLICATION			
SUZUKI	GSXR600/GSXR750	R	06-10
SUZUKI	DL1000	R	14-15
SUZUKI	Vstrom 1000	R	14-18
SUZUKI	GSXR1000	R	07-08
SUZUKI	GSX 300	R	13-15

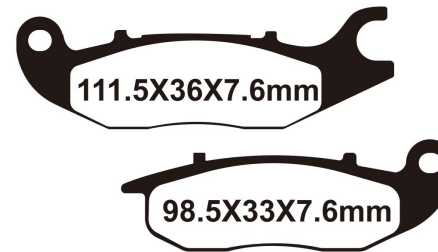

RMO-0026			
APPLICATION			
HONDA	CBR 125	F	04-10
HONDA	CBR RWB/RC/RD	F	11-13
HONDA	MSX 125 Grom	F	14
HONDA	WAVE 125	F	



RMK-0023			
APPLICATION			
BMW	K1200GT	F	03-06
BMW	K1200RS	F	01-05
BMW	K1300GT	F	09-11
BMW	R1150RT	F	01-06

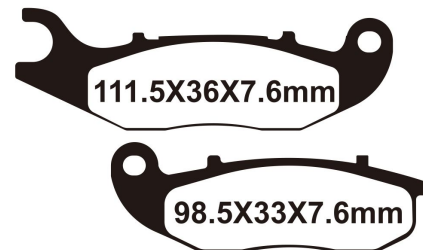

RMO-0026B			
APPLICATION			
HONDA	CRF250 L	F	13-17
SCOPRA	T-Ride 125	F	11
SCOPRA	T-Ride 250 F	F	09-11
APRILIA	SR GT125 SPORT	F	



100X31X8mm

RMO-0027**APPLICATION**

YAMAHA	TW 200	F	01-17
YAMAHA	XT 250	F	08-17
YAMAHA	RXS 115	F	99
YAMAHA	YZF 1000 R1	R	02-03
YAMAHA	YZF 600 R6	R	99-02



41X45X7mm

RMO-0031**APPLICATION**

HONDA	GY6 125	F	
SUZUKI	DR125	F	86-88
SUZUKI	DR125SE	F	94-96
SUZUKI	DR200	F	86-88
SUZUKI	DR200SE	F	97-13



58X33.5X6mm

RMO-0028**APPLICATION**

LIFAN	LF 125 Off Road	F	07
ITALJET	Pit Jet 50 (2T)/125 4T (Pro)	F	07-09
GENERIC	Mini Trigger SM 50/X50	F	08-09
QUADZILLA	WK 140	F	06-08

61.2X27.2
X7mm**RMO-0032****APPLICATION**

YAMAHA	YW 50	F	08-10
YAMAHA	YA 100 W	F	01-03
THUMP STAR	Junior 90cc	F&R	04-07
THUMP STAR	Pro	F&R	05-07

36X45.5
X6mm**RMO-0029****APPLICATION**

CPI	Supermoto 50 SMX	F	
APRILIA	RX 50/RS 50/SX 50	F	
DERBI	ATLANTIS 50 E/GP150 /PREDATOR/GPR 125	F	
PEU GEOT	ELYSEO 50/125/150 E	F	
PEU GEOT	LUDIX 50 E/XPS STREET 50	F	

86.2X40.5
X11mm**RMO-0033****APPLICATION**

MACBOR	125	R	
HONDA	CB500	F	13-14
HONDA	CBR 300R	R	15
HONDA	CBR 650R	R	14
YAMAHA	FZ6R	R	09-11
SUZUKI	GW 250	R	14-15
THUMPH	Tiger 800 XC	R	11-15

36X45.7
X6.5mm**RMO-0030****APPLICATION**

AJP	MX 200	F	09-
BETA	ALP 125 4-stroke	F	00-05
KTM	SX 65	F	00-01
GAS GAS	TXT 50(BOY)	F	04-



69.8X51.7X7.5mm

RMO-0034**APPLICATION**

APRILIA	RS4 50 (4T)/125 (4T)	F	11-13
DERBI	GPR 50 (2T)/125 (4T) 4V	F	09-12
MH/MOTO RHISPANIA	KN2 50	F	12-13
MH/MOTO RHISPANIA	MH7 Naked	F	08-13
PEUGEOT	NK7 "Naked" 50cc	F	09-12



RMO-0035			
APPLICATION			
YAMAHA	FZ 600	R	86-88
YAMAHA	FZR 400	R	88-90
YAMAHA	SRX 250	F	87
YAMAHA	SRX 600	F&R	86

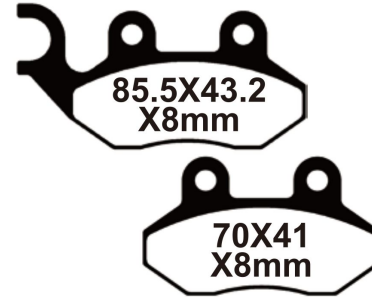

RMO-0039			
APPLICATION			
SYM	Fiddle 125	F	08-14
SYM	Citycom 300i	F&R	08-14
SYM	JET Euro 50	F	99-12



RMO-0036			
APPLICATION			
YAMAHA	FJ 600	F&R	84-85
YAMAHA	YZF 600	R	97-07
YAMAHA	XVS 1100	R	99-09
YAMAHA	FZR 600	R	99-00
YAMAHA	FZ 750	F&R	85-88



RMO-0039B			
APPLICATION			
	ZS110		
	WX110		

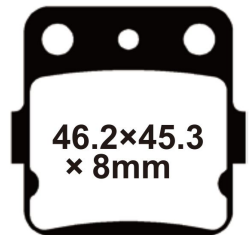

RMO-0037			
APPLICATION			
HONDA	CRF 150	F	07-14
KAWASAKI	KX85	R	01-13
YAMAHA	YZ 85	R	02-14
HONDA ATV	TRX 420	F	09-15
SUZUKI ATV	LT-Z 400	F	03-13
YAMAHA ATV	YFM 250	R	08-13
YAMAHA ATV	YFZ 450	F&R	04-13



RMO-0040			
APPLICATION			
SUZUKI	GN250	F	88
SUZUKI	GN400T	F	80-82
SUZUKI	GN400TX	F	80-81
SUZUKI	GS450ET	F	80-82
SUZUKI	GS750T	F	82-83



RMO-0038			
APPLICATION			
HONDA	CBR600F	F	87-90
HONDA	CBR 600 F2	F	91-94

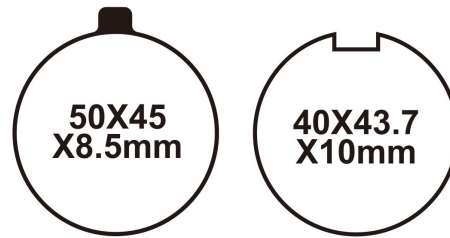

RMO-0041			
APPLICATION			
SUZUKI	V-STROM 650		
SUZUKI	RV 125		
SUZUKI	SV 650		
KAWASAKI	Z 750		
LIFAN	LF 200 GY-S	F	05-08

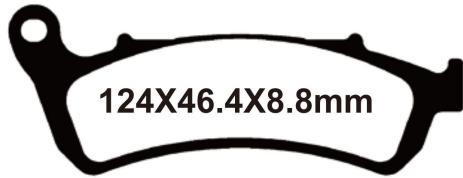

RMO-0042

APPLICATION

SUZUKI	HJ-DK150S		
--------	-----------	--	--

124X46.4X8.8mm

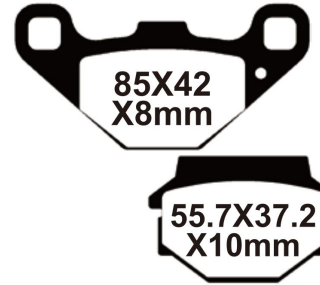

RMO-0046

RMK-0046

APPLICATION

SUZUKI	GN125E	F	91-96
KTM	MX 125	R	92-93
KAWASAKI	KDX200	F	86-92
KAWASAKI ATV	KXT 300	F	88-04
YAMAHA ATV	YFM 300	R	12-13
SUZUKI ATV	LT-A 500	R	03-07

85X42
X8mm

55.7X37.2
X10mm

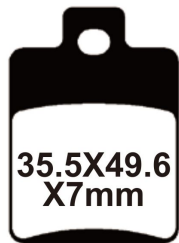

RMO-0043

APPLICATION

PIAGGIO	MP3 250	F	10-14
PIAGGIO	MP3 400	F	07-14
CPI	GTR 150	R	05-09
VESPA	LX 50	F	05-15
VESPA	LXV	F	10-15

35.5X49.6
X7mm



RMK-0047

APPLICATION

GO KART	Mad crok ant.		
---------	---------------	--	--

41.8X38.3
X8mm



RMK-0044

APPLICATION

HONDA	RS 125	R	88-07
HONDA	RS 250	R	88-02
SYM	MIO 50	F	05-14
SYM	DD 50	F	02-12

51.6X36.7X7mm

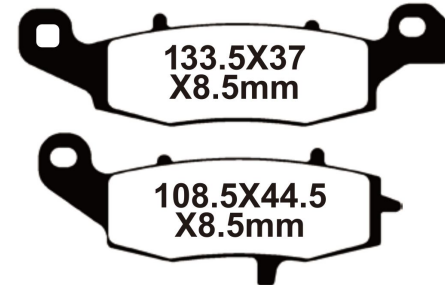

RMK-0048

APPLICATION

KAWASAKI	VN 1700	F Left	09-13
KAWASAKI	VN 2000	F	06-10
KAWASAKI	EX 650	F Left	13-15
SUZUKI	SFV 650	F Left	13-14
SUZUKI	GSX-S 750	F Left	15
SUZUKI	VL 1500	F Left	13-15
SUZUKI	DL 650	F Left	07-14

133.5X37
X8.5mm

108.5X44.5
X8.5mm

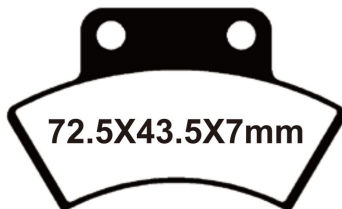

RMK-0045

APPLICATION

POLARIS	ALL DISC REAR BRAKE MODELS	R	89-95
E-TON QUADS	RXL-50M VIPER	PARKING	

72.5X43.5X7mm

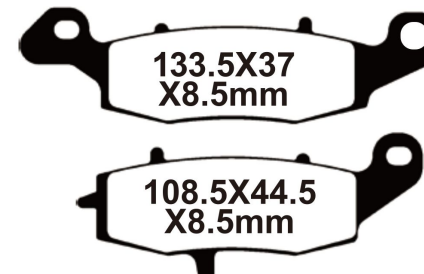

RMK-0049

APPLICATION

KAWASAKI	VN 1700	F Right&R	09-13
KAWASAKI	VN 2000	R	06-10
KAWASAKI	EX 650	F Right	13-15
SUZUKI	SFV 650	F Right	13-14
SUZUKI	GSX-S 750	F Right	15
SUZUKI	VL 1500	R	13-15
SUZUKI	DL 650	F Right	07-14

133.5X37
X8.5mm

108.5X44.5
X8.5mm

RMO-0050 **RMK -0050**
RMS -0050

APPLICATION

HONDA	CRF 125R	F	14-15
HONDA	XR 650	F	93-15
KAWASAKI	KLX 450 F	F	09-15
ZUKUZI	RM-Z 450	F	05-15
YAMAHA	WR 250	F	01-13
YAMAHA	YZ 450	F	03-14
TM	125	F	
KTM	BREMBO	F	



RMK -0054

APPLICATION

BMW	K1	F	88-93
BMW	K1200 RS	F	97-10
BMW	K1100 RS	F	96-11
BMW	R850R	F	96-02
BMW	R1200C	F	96-02

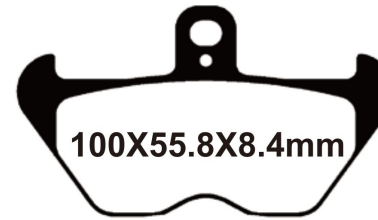

RMK -0051
RMS -0051

APPLICATION

APRILIA	RSV 4	F	11-14
BMW	HP4 1000CC	F	13-14
SUZUKI	GSXR 600	F	11-14
SUZUKI	GSX-S 1300	F	13-15
HONDA	CBR 100 RRA	F	14
	BREMBO ROAD	F	



RMK -0055

APPLICATION

YAMAHA	XV 535 S Virago (4KUF)	F	91-95
--------	------------------------	---	-------

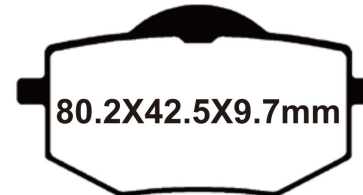

RMK -0052

APPLICATION

SUZUKI	GS 500	R	89-10
SUZUKI	GSXR 750	R	00-03
SUZUKI	GSF 600	R	00-03
KAWASAKI	ZRX 1200 R	R	01-05
KAWASAKI	ZX-12R	R	00-05

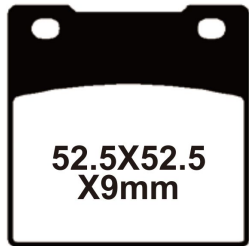

RMK -0056

APPLICATION

SUZUKI	RG 80	F	86-95
--------	-------	---	-------

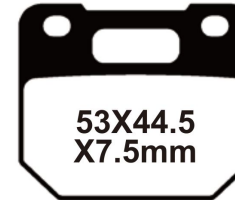

RMK -0053

APPLICATION

GO KART	CRG Ven 05		
---------	------------	--	--



RMK -0057

APPLICATION

GO KART	Mad crok post		
---------	---------------	--	--





RMK -0058			
APPLICATION			
KAWASAKI	KZ 305 B2/B3	F	87-88
KAWASAKI	KZ 550 F1	F	83-84
KAWASAKI	KZ 750 M1	F&R	82-83
KAWASAKI	KZ 1000 P1-P20	F&R	82-01
KAWASAKI	KZ 1100 82-83	F	82-83



RMO-0062			
RMK -0062			
APPLICATION			
HONDA	CR 125R/250R	F	87-94
HONDA	XR 250	F	88-95
HONDA	VFR 750R	R	90
HONDA ATV	TRX 250R	F	86-89
HONDA ATV	ATC 350 X	F	86

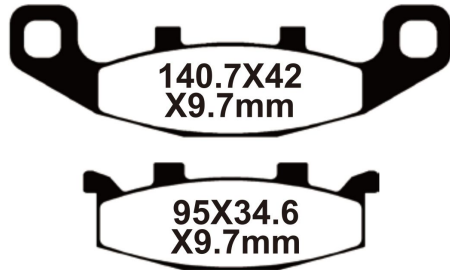

RMK -0059			
APPLICATION			
KAWASAKI	EX 250 Ninja 250R	F	88-07
KAWASAKI	ZL 600 Eliminator	F	96-97
KAWASAKI	ZX 1100 Ninja	R	90-93
KAWASAKI	KL 650 B2/B3	F	90-91
SUZUKI	GSF 400 BANDIT	F	91-93
SUZUKI	GS 500	F	89-95

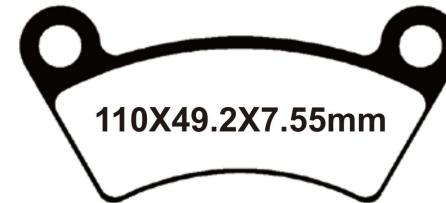

RMK -0063			
APPLICATION			
KEEWAY	GTX 300 Quad	R	10-11
LINHAI	CUV Jobber 4x4	F	13-
QUADZILLA	CUV 300	F	08-09
QUADZILLA	325 4x4	R	10-11



RMO-0060			
RMK -0060			
APPLICATION			
KAWASAKI	KX 125	R	89-94
KAWASAKI	KDX 200	R	97-06
KAWASAKI	KLX 650	R	93-96
YAMAHA	XT 250	R	08-15
YAMAHA	YZ 250	R	91-97
SUZUKI	DR 250	R	90-95
SUZUKI	RM 250	R	91-95

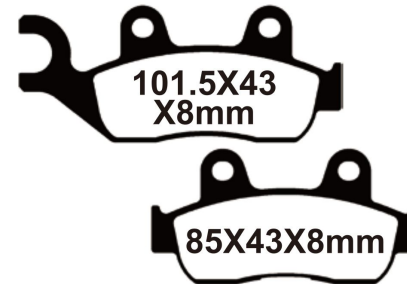

RMO-0064			
APPLICATION			
KYMCO	Grand Dink 250		
HONDA	WY 125		
HONDA	WY 150		

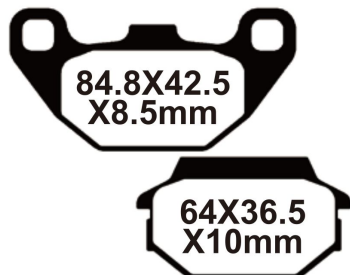

RMK -0061			
APPLICATION			
ARCTIC CAT	50 DVX (4T) Sport	R	06-08
KAWASAKI	KXF 90	R	07-15
KYMCO	Agility 50	R	16
KYMCO	MXU 150	R	05-14
KYMCO	SUPER 8	F	07-14
SYM	HD 125/200	F	08-12
SYM	HS 125/200	F	04-08



RMK -0065			
APPLICATION			
POLARIS ATV	ATP 300	F&R	04-05
POLARIS ATV	Sportsman 800	F	08-14
POLARIS ATV	Sportsman 700	F	02-07
POLARIS ATV	Scrambler 500	F	97-12



73X52.6X7mm

RMK-0066

APPLICATION

POLARIS ATV	Diesel 455	R	99-01
POLARIS ATV	Magnum 325	R	00-01
POLARIS ATV	Sportsman 500	R	98-02
POLARIS ATV	Trail Blazer 250	R	99-04
POLARIS ATV	Trail Boss 325	R	00-02



55.5X49X7.6mm

RMO-0070

APPLICATION

PIAGGIO	FLY 150	R	13-14
VESPA	946	R	13-15
VESPA	GT 200L	R	05-09
VESPA	GTS 300 Super	R	10-15
VESPA	GTV 300	R	10-15



55.3X46X7.5mm

RMO-0067

APPLICATION

KYMCO	Grand Dink 250	R	05-11
KYMCO	GRAND VISTA 240	R	05-11



94X36X10mm

RMO-0071

APPLICATION

DAELIM	ET 250 Quad	R	05-08
DAELIM	ST 250 Sector Quad	R	05-06
KYMCO	People S 125 DD/200i DD	R	07-11
KYMCO	Xcelting 300i R	R	08-10
SYM	GTS 125 Joymax	R	06-09

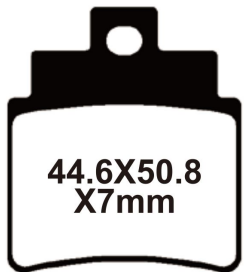

44.6X50.8
X7mm

RMO-0068

APPLICATION

ARCTIC CAT	250 DVX	R	06-08
ARCTIC CAT	300 DVX	R	09-12
SYM	RV 250	F	07-12
KYMCO	MXU 250	R	04-10
KYMCO	KXR 250 Mongoose	R	04-10
KYMCO	Mongoose 300	R	06-12



77X41X7.5mm

RMO-0072

APPLICATION

BETA	RK6 50cc Enduro	F	97-02
PEUGEOT	XR 6 50CC	F	03-05
YAMAHA	NXC 125-Cygnus X	F	07-13
APRILIA	Classic 125	F	96-01
EXPLORER	KBR 200	F	05
GAS-GAS	EC 50 Rookie	F	01-04
GAS-GAS	SM 50 Rookie	F	01-04

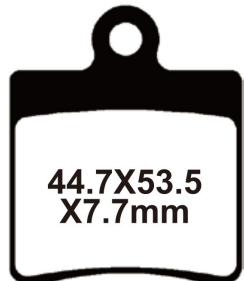

44.7X53.5
X7.7mm

RMO-0069

APPLICATION

DAELIM	B-Bone 125(SW12)	F	09-14
--------	------------------	---	-------

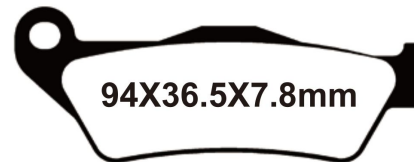

94X36.5X7.8mm

RMO-0073

RMK-0073

APPLICATION

YAMAHA	FZ 16	F	10-13
BAJAJ	PULSAR 200	F	
BMW	R 1200 R	R	06-11
BMW	K 1300 S/R	R	09-15
KTM	EXC MX	F	

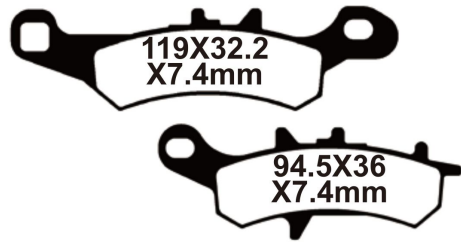

RMO-0074

APPLICATION			
TVS	FIERO F2		



RMK-0078

APPLICATION			
	GO KART		



RMK-0075

APPLICATION			
TONY KART	OKT BS5		
TONY KART	OKT BS6		

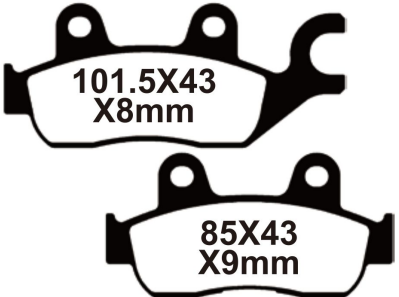

RMO-0079

APPLICATION			
GILERA	STORM125		
HONDA	CB190R		
HONDA	WH150-3-3A		
HONDA	WH125-B-7-8-11		



RMK-0076

APPLICATION			
	GO KART		



RMO-0080

APPLICATION			
HONDA	SCR110	F	13-14
HONDA	MOJET125	F	13-14



RMK-0077

APPLICATION			
HARLEY-DAVIDSON	FLHTK Electra Glide	F&R	08-18
HARLEY-DAVIDSON	FLHTCUL Electra Glide Low	F&R	15-16
HARLEY-DAVIDSON	FLTR Road Glide	F&R	08-09
HARLEY-DAVIDSON	VRSCAW V-Rod	F&R	08-11



RMK-0081

APPLICATION			
CF MOTO	CF 500-2 Terralander	F	13
EXPLORER	Everest 500 L4x4	F	08-09
QUADZILLA	CVT 150 E	F	10-11
QUADZILLA	CVT 320 e	F	07-11
QUADZILLA	ZX6 4x4	F	10-13

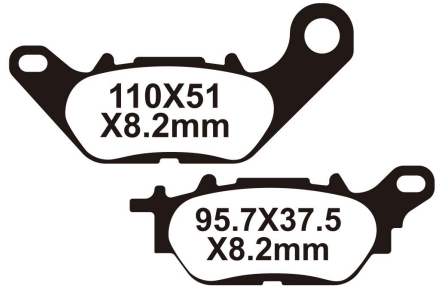

RMO-0082				
APPLICATION				
YAMAHA	YBR 125/250	F	11-12	
YAMAHA	YZF-R15	F	10-13	
YAMAHA	JUPITER MX			
YAMAHA	MIO NEW			
YAMAHA	SNIPER 135			

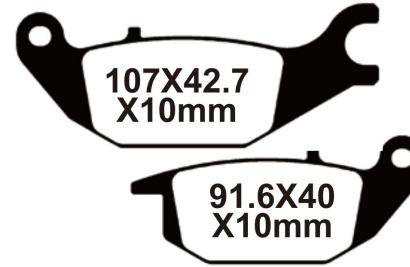

RMO-0086				
APPLICATION				
HONDA	CBR125R	R	04-06	
HONDA	CBR 150 R	R	00-03	
HONDA	XL 125	R	01-11	
YAMAHA	YZF-R15	R	10-13	
HERO	Karizma ZMR 230	R	11-12	
AJS	Regal Raptor CR3-125	R	06	

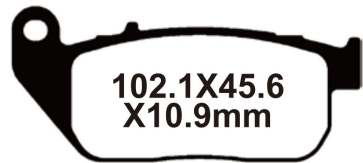

RMK-0083				
APPLICATION				
HARLEY-DAVIDSON	XL 1200 X Sportster Forty Eight	F	10-13	
HARLEY-DAVIDSON	XL 883 N Iron	F	09-13	
HARLEY-DAVIDSON	XL 883 Sportster	F	04-08	
HARLEY-DAVIDSON	XL 1200 C Sportster	F	04-13	

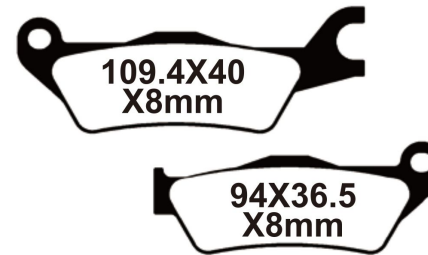

RMO-0087				
APPLICATION				
HONDA	HERO			
HONDA	CBZ			
HONDA	EXTREME HUNK			
HONDA	CBF125/150			
HONDA	CD100			
HONDA	XL200		97-01	



RMK-0084				
APPLICATION				
HARLEY-DAVIDSON	XL 1200 X Sportster Forty Eight	R	10-12	
HARLEY-DAVIDSON	XL 883 Sportster	R	09-13	
HARLEY-DAVIDSON	XL 1200 C Sportster	R	04-08	
HARLEY-DAVIDSON	Sportster 883	R	04-13	

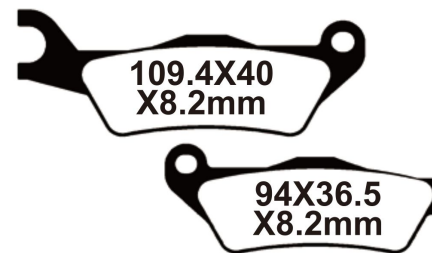

RMO-0087B				
APPLICATION				
HONDA	HERO-Hunk			



RMO-0085				
APPLICATION				
SYM	RS 50	F	04-10	
SYM	RV 200 EVO	F	12-14	

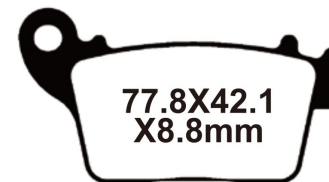

RMK-0088				
APPLICATION				
HONDA	CBR1000RR	R	06-17	
HONDA	CBR600RR	R	07-17	
KAWASAKI	ZX-6R 636CC/ NON ABS	R	13-15	
KAWASAKI	ZX 10R NON ABS	R	11-15	
SUZUKI	GSXR 600	R	11-15	
SUZUKI	GSXR 1000	R	15	



97.5X51.5
X7.7mm

RMK-0089

APPLICATION

POLARIS ATV	RZR 900	R	15
POLARIS ATV	RZR-S 900	R	15

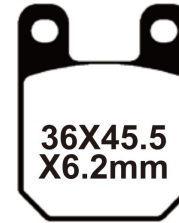

36X45.5
X6.2mm

RMO-0093

APPLICATION

BETA	ALP 200 4T	F&R	00-06
PEUGEOT	METAL-X	F	02-05
PEUGEOT	ELYSEO 50	F&R	02-05
PEUGEOT	LUDEX 50	F	04-05
GASGAS	TXT 50(BOY)	F	04-11



85X52X7mm

RMO-0090

APPLICATION

YAMAHA	MIO	F	
YAMAHA	EGO	F	

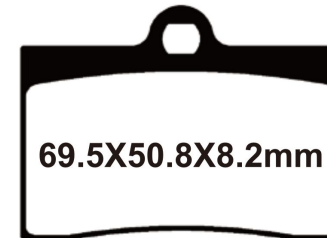

69.5X50.8X8.2mm

RMO-0094

RMK-0094

APPLICATION

BREMO	20 5165 55/68		
DUCATI	748 SP/BIPOSTO	F	91-98
GAS GAS	SM125/250	F	01-05
HUSQVARNA	SM450R	F	03-06
KTM	DUKE 125	F	11
APRILIA	RS 125 E5	F	



74X36.7
X8.9mm



40X27
X10mm

RMO-0091

APPLICATION

	Chinese electric scooter		
--	--------------------------	--	--



39.8X53.8
X6.5mm

RMO-0095

APPLICATION

YAMAHA	CW50T	F	99-01
YAMAHA	YG50ZR	F	95-00
YAMAHA	YN50 NEOS	F	02-06
YAMAHA	YQ	F	97-10
MBK	BOOSTER NEXT	F	00-03
MBK	OVETTO	F	00-03



74X36.7
X9mm



40X27
X10mm

RMO-0092

APPLICATION

LIFAN	LF 125 Off Road		
QUADZILLA	WK 140		
STOMP MINI MOTO	125cc Elite		
	Chinese electric scooter		



119X32.2
X7.4mm



94.5X36
X7.4mm

RMO-0096

APPLICATION

TVS	VICTOR GLX		
-----	------------	--	--

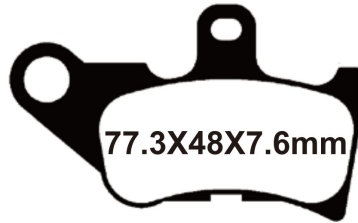
**RMO-0097****APPLICATION**

YAMAHA	CV 50 (5KN1/2)Jog-Cool Style	F	00-02
YAMAHA	MiO Sporty (113cc)	F	05-07
YAMAHA	Nuovo-Z (113cc)	F	06-07

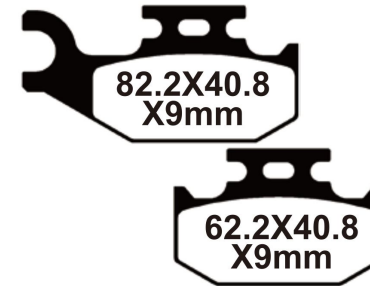
**RMK-0101****APPLICATION**

SUZUKI	LT-A 500 FK2 Vision 4WD	R	02
JOHN DEERE ATV	Most models	F Right & R	04-08
CAN-AM	Most models	F Right & R	07-13
BOMBARDIER	Most models	F Right & R	01-06

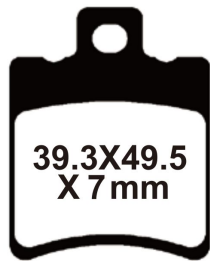
**RMO-0098****APPLICATION**

PIAGGIO	TYPHOON 50	F	07-09
APRILIA	SR 50	F	04-15
APRILIA	SCARABEO 100 4T	F	04-14
YAMAHA	CW 50	F	99-01

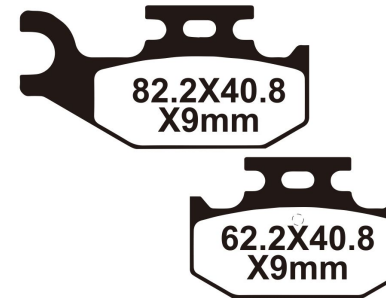
**RMK-0101B****APPLICATION**

YAMAHA	YXR 66 FAS/FAT/FAV Rhino	R	04-06
YAMAHA	YFM 700	R	06-12

**RMO-0099**
RMK-0099**APPLICATION**

YAMAHA	YZ 80	F	86-01
YAMAHA	YZ 85	F	02-14
YAMAHA	TT-R 125	F	00-15

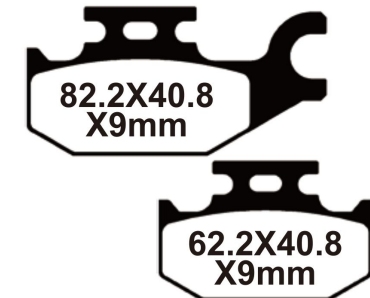
**RMK-0102****APPLICATION**

YAMAHA	YFM 450 FGW/FGX/FGY Grizzly	R	07-09
BOMBARDIER	Most models	F Left&R	01-06
CAN-AM	Most models	F Left&R	07-13
JOHN DEERE ATV	Most models	F Left&R	04-08
SUZUKI	UX 125/150	R	08-11

**RMK-0100****APPLICATION**

BMW	K 75-S	F&R	85-09
BMW	K 1200 RS	R	96-05
DUCATI	600 Panth	F	81
DUCATI	750 Sport	F&R	88-90
DUCATI	1000 R1 Hailwood Replica	F&R	84
MOTO GUZZI	850 Le Mans I	F&R	78-84
MOTO GUZZI	1000 S	F&R	89-94

**RMK-0103****APPLICATION**

HONDA	CBF 600	R	98-06
HONDA	CB 1300	R	03-11
KAWASAKI	KLZ 1000	R	12-13
SUZUKI	GSX 650	R	08-09
SUZUKI	DL 650	R	09-11
YAMAHA	FZ8	R	11-13
YAMAHA	Fazer 8	R	11-13



RMK-0104 4 PCS/SET				
APPLICATION				
BENELLI	TNT 1130	F	06-12	
APRILIA	RSV 1000 R Factory	F	04-08	
KTM	690 Duke	F	08-11	
KTM	990 Supermoto	F	09-13	
MOTO GUZZI	1000 MGS-01 Corsa	F	04-07	

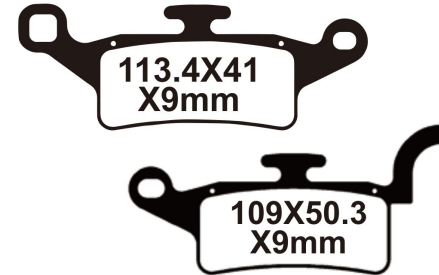

RMO-0108			
APPLICATION			
YAMAHA	HW125/Xenter 125	F	12-13
YAMAHA	YW 125 (BW's 125)	F	10-13
YAMAHA	HW150/Xenter 150	F	12-13
MBK	YW 125 Z X-Over	F	10

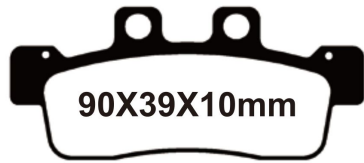

RMO-0105			
APPLICATION			
YAMAHA	NCX 125 K "Cygnus X Cab"	F	07-10
YAMAHA	YW 125 X	F	10-13
SYM	SB 250 Ni	F	12-13



RMO-0109			
APPLICATION			
HUSQV ARNA	Husky Boy 50	F&R	98-99
HYOSUNG	TE 50	R	05-07
HYOSUNG	TE 90	R	05-07
HYOSUNG	TE 100	R	05-07

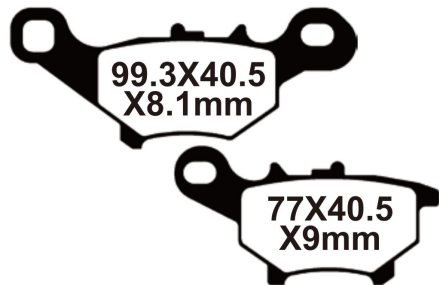

RMO-0106			
APPLICATION			
YAMAHA	CV 50 A/R Jog	F	03-08
AEON	CO IN Eco (Electric)	F	13
AEON	CO IN 125 (4T)	F	13



RMO-0110			
APPLICATION			
TVS	Apache Rtr 180		



RMO-0107			
APPLICATION			
KYMCO	Downtown/Superdink 125i	R	09-13
KYMCO	People GT 125i	R	10-13
KYMCO	Downtown 300i (ABS/V20010)	R	10-13
BENELLI	Velvet 125/150 (Touring)	R	08-11



RMO-0111			
APPLICATION			
BAJAJ	PULSAR220		

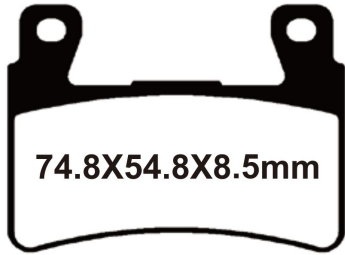

RMO-0112			
RMK-0112			
APPLICATION			
HONDA	CBR 600 F3/F4/F5/F6	F	03-06
HONDA	RVT 1000 R	F	00-06
HONDA	CB 1300	F	05-12
KAWASAKI	ZX-6R EDF/FDF	F	13
HARLEY-DAVIDSON	XR 1200 X	F	10-12



RMK-0116			
APPLICATION			
DUCATI	Supersport	F	95-07
BENELLI	TNT 1100	F	04
KEEWAY	ENDURO	F	07
KTM	XCE 640 DUKE	F	99-02



RMK-0113			
APPLICATION			
	GO KART		

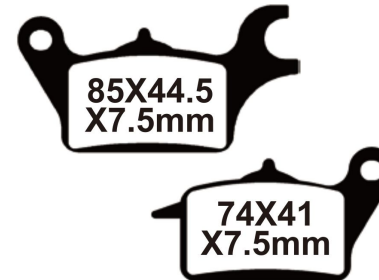

RMO-0117			
APPLICATION			
KAWASAKI	Z 125	F	16-19
KAWASAKI	Z125 PRO	F	16-19
HONDA	WAVE110-RS	F	
YAMAHA	MW 125 Tricity Scooter	F Right	14-16
YAMAHA	MWS 125 Tricity Scooter	F Right	17-18



RMK-0114			
APPLICATION			
HONDA	CBR 600RR	F	05-15
HONDA	CBR 1000	F	04-15

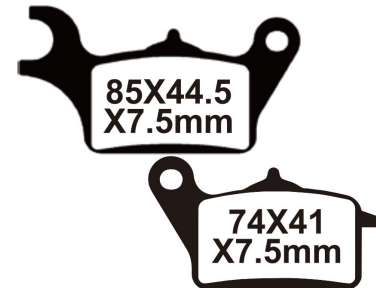

RMO-0117B			
APPLICATION			
HONDA	NCX 50 Dunk 50	F	14-17
HONDA	NSC 110 MPDH Vision	F	17-18
HONDA	ACD 110 Scoopy 110 Fi	F	11-16
HONDA	ACA 125 Air Blade 125	F	14-16
HONDA	Super Cub 125	F	18-19
YAMAHA	MW 125 Tricity Scooter	F Left	14-16
YAMAHA	MWS 125 Tricity Scooter	F Left	17-18

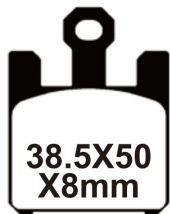

RMK-0115 4 PCS/SET			
APPLICATION			
KAWASAKI	ZX-6RR/ZX6R	F	03-06
KAWASAKI	ZX 10 R	F	04-07
KAWASAKI	VN 1600	F	05-08
SUZUKI	GSXR 1000 K3	F	03
SUZUKI	M 1600/VZ	F	05
SUZUKI	VZ 1600 K5	F	05



RMK-0118			
APPLICATION			
KAWASAKI	ZX6R	F	00-02
KAWASAKI	ZX12R	F	00-03
KAWASAKI	ZRX 1200	F	01-05
KAWASAKI	VN 1600	F	04
SUZUKI	GSXR 1000 K1/K2	F	01-02
SUZUKI	GSX 1300 RX	F	99-06
SUZUKI	GSX 1400	F	01-07

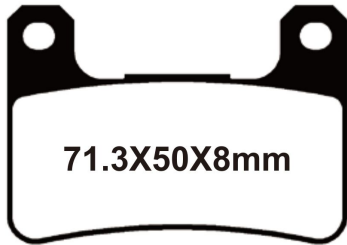

71.3X50X8mm

RMK-0119

APPLICATION

KAWASAKI	ZX10R	F	08-10
KAWASAKI	ZR 1000 DAF	F	10-13
SUZUKI	GSXR 600 K4	F	04-10
SUZUKI	GSXR 1000	F	04-11
SUZUKI	M 1800 RZ	F	07-13
SUZUKI	VZR 1800 K6	F	06-09



102.2X39X9mm

RMO-0123

RMK-0123

APPLICATION

HONDA	CBR 250 RB/RC	F	11-13
HONDA	CB 750	F	92-02
KYMCO	Downtown/Super Dink 125i	F	09-13
KYMCO	Xciting 500 Ri	F	09-12
YAMAHA	WR 125 X	F	09-13
TRIUMPH	Thruxton 900	F	04-13
MACBOR	500	F	

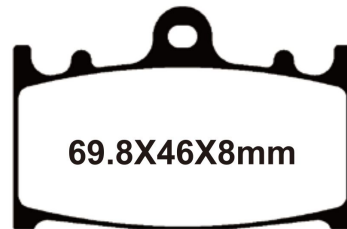

69.8X46X8mm

RMK-0120

APPLICATION

KAWASAKI	ZZR 400	F	90-99
KAWASAKI	KLZ 1000 ACF/ADF	F	12-13
KAWASAKI	VN 1700 KBF/KCF/KDF	F	11-13
SUZUKI	GSX 1250	F	10-13
SUZUKI	GSR 600 K6/K7/K8	F	06-10

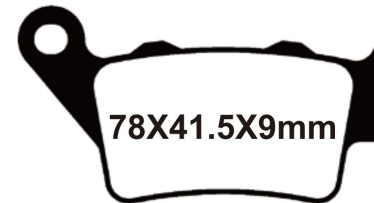

78X41.5X9mm

RMK-0124

APPLICATION

BAJAJ	PULSAR 220	R	
YAMAHA	TT 600 R	R	97-02
YAMAHA	XT 660 Z Tenere	R	08-13
KTM	Duke 620 LC4	R	94-98
KTM	EXC 520	R	01-03
KTM	690 Enduro R	R	09-13



68X53.5X8mm

RMK-0121

APPLICATION

HONDA	CB 1000	F	94-95
HONDA	CBR 900 RR	F	93-97
HONDA	Super Hawk 1000	F	00-05
HONDA	VFR750 R	F	90



74.6X55X8.6mm

RMO-0125

APPLICATION

BMW	F 800 R	F	09-13
BMW	G 650 Xmoto	F	07-09
APRILIA	RSV 1000	F	03-05
APRILIA	SL 1000	F	00-04
BENELLI	TNT 899	F	07-13
BENELLI	TRE-K 1130	F	06-13
KTM	SMC	F	05



68X36X7mm

RMO-0122

APPLICATION

Chinese electric scooter

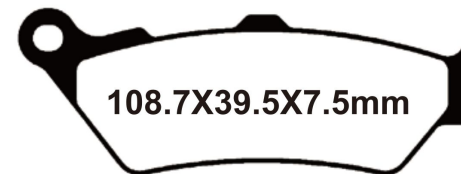

108.7X39.5X7.5mm

RMK-0126

APPLICATION

HONDA	CB 500	F	97-03
HONDA	NX 500	F	97-02
BMW	F 650 GS	F	07-12
BMW	K 1600 GT	F	11-13
TAMAHA	DT 125 X	F	05-06
TAMAHA	XT 660 R	F	04-13



49.8X42.4
X7.5mm

RMO-0127

APPLICATION

Chinese electric scooter



67.1X44.2X7mm

RMK-0131

APPLICATION

MASSEY FERGUSON (ATV)	MF 250	F&R	04
MASSEY FERGUSON (ATV)	MF 300	F&R	04
MASSEY FERGUSON (ATV)	MF 400 4WD	F&R	04
ARCTIC CAT	Most models	F&R	96-04
LAVERDA	Quasar 4x4 500c	F&R	04



50.5X53.6
X7.6mm

RMK-0128

APPLICATION

APRILIA	ETV 1000	R	06-11
APRILIA	RSV 1000 R	R	04-08
CF MOTO	CF 125 T-22/150 T-6A	R	10-12
BENELLI	TNT 1130	R	05-12
PIAGGIO	X9 125 Evolution	R	05-07
PIAGGIO	Beverley Cruiser 500 ie	F&R	07-11

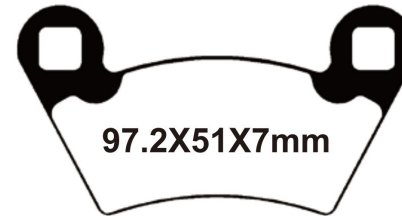

97.2X51X7mm

RMK-0132

APPLICATION

POLARIS	500 Ranger 4x4 Efi	F&R	11-12
POLARIS	Ranger 6x6 EFI 700	F&R	06-09
POLARIS	Ranger RZR XP 900	R	11



69.7X51X8.7mm

RMK-0129

APPLICATION

YAMAHA	FZ6 Fazer S2	F	07-09
YAMAHA	TDM 900	F	05-13
YAMAHA	XJR 1300	F	05-12
YAMAHA	XV1900	F	06-12



94.7X46X7mm

RMK-0133

APPLICATION

ARCTIC CAT ATV	250 (2X4) (Utility)	F&R	05-09
ARCTIC CAT ATV	550 GT TRV	F&R	11-12
ARCTIC CAT ATV	700i Ltd	F&R	11-12
ARCTIC CAT ATV	1000 Mudpro	F&R	10-11
ARCTIC CAT ATV	XTX 700i Prowler	F&R	11-12
KYMCO	MXU 400 (A40000)	F&R	08-11
KYMCO	MXU 450 i (4x4 Lof)	F&R	12-13

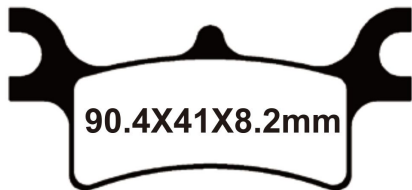

90.4X41X8.2mm

RMK-0130

APPLICATION

POLARIS	Magnum 330	R	03-06
POLARIS	330 Trial Boss	R	05-11
POLARIS	500 Sportsman EFI Quad	R	08-11
POLARIS	330 Trial Blazer	R	08-11

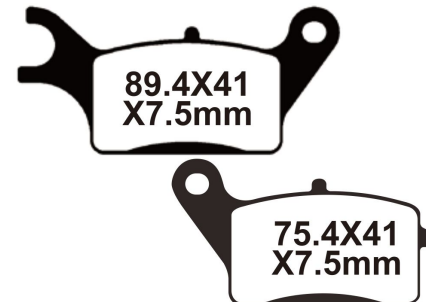

89.4X41
X7.5mm

75.4X41
X7.5mm

RMK-0134

APPLICATION

HONDA	BEAT	F	
-------	------	---	--



111X44.6X7.8mm



109.5X42X7.8mm

RMO-0135

APPLICATION

HONDA	PCX 125	F	11
HONDA	PCX 150(WW150)	F	13-15
HONDA	NSC 50 AC Vision 50 (4T)	F	12-13
HONDA	NSC 110 Vision 110 (4T)	F	11-13



111X44.6X8mm



109.5X42X8mm

RMO-0135B

APPLICATION

DAYTONA	DY 125 RS EURO4		17
MACBOR	125	F	



30.8X48
X9mm

RMK-0138

APPLICATION

YAMAHA	YZF-R1		
--------	--------	--	--

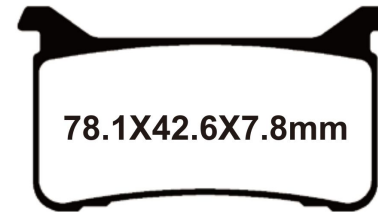

78.1X42.6X7.8mm

RMK-0139

APPLICATION

HONDA	CRF CRF1000 Africa Twin 2018		18
-------	------------------------------	--	----



96.6X39X7mm

RMK-0136

APPLICATION

CF MOTO	CF 625-B/C X6 Terralander	F	11-13
CF MOTO	CF 800-2 Terralander	F	12-13
QUADZILLA	CVT 150 E	F	10-11
QUADZILLA	CUV 500 Side x Side	F	10-11
QUADZILLA	X8 (4x4/EFI)	F	12-13
EXPLORER	Atlas 500/4x4	F	08-09
EXPLORER	Everest 500 L/4x4	F	08-09

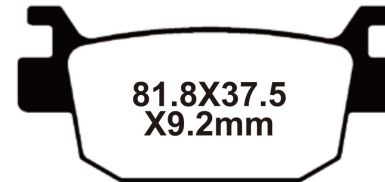

81.8X37.5
X9.2mm

RMO-0140

APPLICATION

HONDA	FES 125/150 A7/A9/AAS-Wing	R	07-13
HONDA	SH 125i RA Fuel Injection	R	10-13
HONDA	NSS 250 X5/X7/X8 Forza	R	05-08
HONDA	SH 300i A7/A8/A9/AA/AB/AC	R	07-13

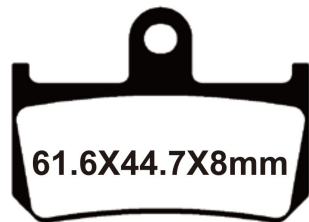

61.6X44.7X8mm

RMK-0137

APPLICATION

YAMAHA	YZF-R1		
--------	--------	--	--

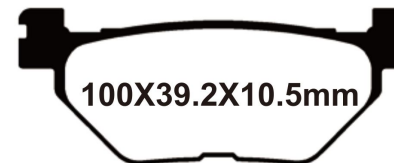

100X39.2X10.5mm

RMK-0141

APPLICATION

YAMAHA	XVS 950	R	09-13
YAMAHA	FJR 1300	R	03-14
YAMAHA	XV 1700	R	09-11
YAMAHA	XV1900	R	06-12
YAMAHA	T-Max 530	R	12
YAMAHA	XP 530 Black Max	R	13
SYM	Voyager 250	R	05



85X35
X8mm



54.8X36.5
X9.4mm

RMK -0142

APPLICATION

KAWASAKI ATV	KXF 250	F	87-88
KAWASAKI ATV	KSF 250	F	87-04
KAWASAKI ATV	KEF 300	F	01-02
SUZUKI ATV	LT 250 RH/RJ/RK/RL	F	87-90
SUZUKI ATV	LT 500 RL	F	90

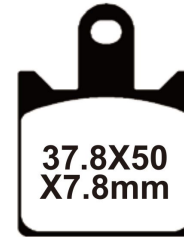

37.8X50
X7.8mm

RMK -0146

APPLICATION

KAWASAKI	ZX6R	F	07-13
KAWASAKI	Z 750 R	F	11-12
KAWASAKI	Z 1000	F	07-09
KAWASAKI	GTR 1400	F	08-13
KAWASAKI	ZZR 1400	F	06-13

RMK -0143

APPLICATION

KAWASAKI ATV	KSF 400	R	03-05
ARCTIC CAT	400 DVX (2x4) Sport	R	04-08
ARCTIC CAT	400 DVX TS Sport	R	06-07
SUZUKI ATV	LT 250	R	87-90
SUZUKI ATV	LT-Z 400	R	03-12
SUZUKI ATV	LT-R 450	R	06-12
SUZUKI ATV	LT 500 RL	R	87-90



46.8X45
X7.6mm

RMK -0147

APPLICATION

YAMAHA ATV	YFM 250	F LEFT	08-13
YAMAHA ATV	YFM 550 Grizzly	F LEFT	09-14
YAMAHA ATV	YFM 700 Grizzly	F LEFT	07-13/15

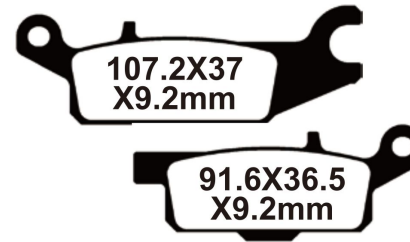

107.2X37
X9.2mm



91.6X36.5
X9.2mm

RMK -0144

APPLICATION

HONDA	NT 700	R	06-13
HONDA	VFR 800 A6/A8/A9	R	06-13
HONDA	XL 1000 Varadero	R	07-11
HONDA	CBR 1100 'Blackbird'	F&R	97-08
HONDA	GL1800	R	06-13
VICTORY	Vision Tour (All models)	F	08-12
VICTORY	Arlen Ness Victory Vision	F	10-12



114.5X39X8.3mm



107.2X37
X9.2mm



91.6X36.5
X9.2mm

RMK -0147B

APPLICATION

YAMAHA ATV	YFM 250	F Right	08-13
YAMAHA ATV	YFM 550 Grizzly	F Right	09-14
YAMAHA ATV	YFM 700 Grizzly	F Right	07-15

RMO-0145

APPLICATION

APRILIA	SR 50 R/Factory	R	04-13
APRILIA	Sport City Cube 125	R	08-12
APRILIA	RS 50	F	
BENELLI	X 125/150	R	12-13
KEEWAY	RKV 125	R	10-12
BETA	Eikon 150	R	04



50.8X53
X9.5mm

RMK -0148

APPLICATION

KAWASKI	KFX 450 R Quad	F Left	08-11
KAWASKI	KVF 650	F Left	05-11
KAWASKI	KVF 700	F Left	04-08
SUZUKI	LT-V 700 FK4/FK5 Twin Peaks	F Left	04-05



119.8X26.6
X7.2mm



95.5X35.6
X7.8mm

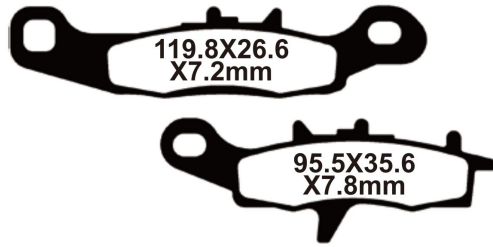

RMO-0148B				
RMK -0148B				
APPLICATION				
KAWASKI	KX80	F	97-00	
KAWASKI	KX 85	F	01-15	
KAWASKI	KX 100	F	97-15	
KAWASKI	KL 250	F	00-04	
SUZUKI	RM85	F	05-15	
SUZUKI	RM 100 K3	F	03	



RMO-0152				
RMK -0152				
RMS -0152				
APPLICATION				
HUSQVA RNA	CR125/250	R	05-13	
HUSQVA RNA	TC 250	R	05-14	
HUSQVA RNA	TE 250	R	06-12/14	
KTM	SX 125	R	04-15	
KTM	EXC 125	R	04-17	
KTM	XC 250	R	04-07	

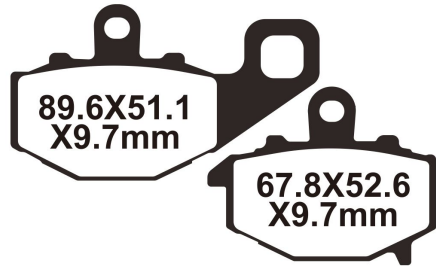

RMK -0149				
APPLICATION				
KAWASAKI	ZX-6R	R	09-13	
KAWASAKI	ER-6f	R	06-11	
KAWASAKI	KLE 650	R	07-13	
KAWASAKI	Z 1000 SX	R	11-13	
CF MOTO	650 NK	R	12-13	
CF MOTO	650 TR	R	13	

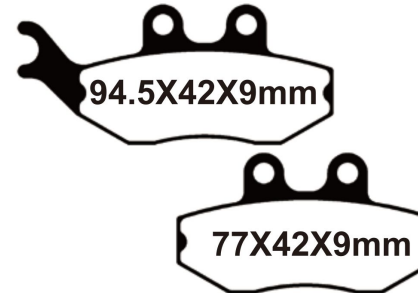

RMO-0153				
APPLICATION				
PIAGGIO/ VESPA	Beverley B 125	F&R	03-06	
PIAGGIO/ VESPA	Skipper ST 125/150 4T Grimeca Calliper	F	00-04	
KEEWAY	X Ray 50 Supermoto	F	08-09	
PEUGEOT	Geopolis 125 RS	F	03-09	
SHERCO	Enduro 50 (EN50)	F	08-13	
AJP	Supermoto Enduro 125/250	F		

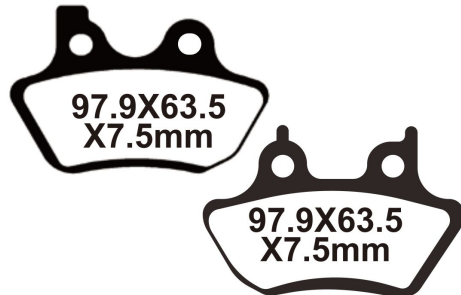

RMK -0150				
APPLICATION				
HARLEY DAVIDSON	Most models	F	06-07	

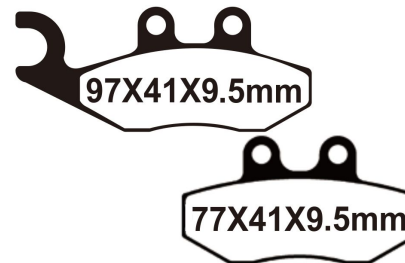

RMO-0154				
APPLICATION				
AJP	PR3/PR4	F	08-10	
PIAGGIO/ VESPA	X7 300 Evo	F	09-10	
PIAGGIO/ VESPA	Xevo 125 ie	F	07-10	
PIAGGIO/ VESPA	GTS 250 ie/ABS	F	05-10	
APRILIA	SR125	F	12-16	
APRILIA	GTS125	F	17-19	
VESPA	GTS 250 ie/ABS	F	05-11	

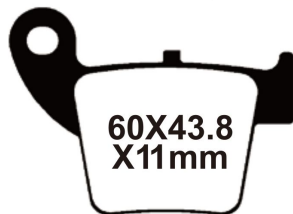

RMO-0151				
RMK -0151				
RMS -0151				
APPLICATION				
HONDA	CR 125	R	02-07	
HONDA	CRF150	R	07-14	
HONDA	CR 250 R Moto	R	02-15	
HONDA	CRF 450	R	02-15	
TM	85	F/R		

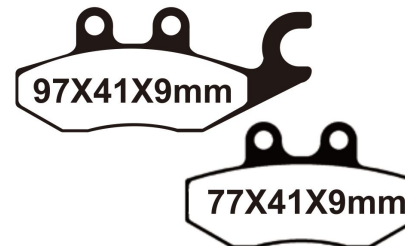

RMO-0154B				
APPLICATION				
PIAGGIO	Beverly 125 (4T)	R	11-14	
PIAGGIO	MP3 Hybrid	R	09-12	
PIAGGIO	Beverly 300 Sport Touring	R	10-15	
PIAGGIO	X7 300 Evo	R	09-12	
PIAGGIO	GTS 300 ie Super	R	08-18	



88X40X9mm

RMO-0155

APPLICATION

HONDA	HONDA-CBR 125	R	11-13
HONDA	CBF 250(NEW MEGA PRO; KRZ FRONT)	R	13-19

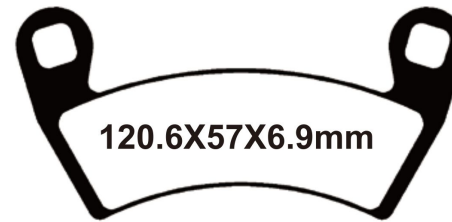

120.6X57X6.9mm

RMK-0159

APPLICATION

POLARIS	400 Ranger	F	10
POLARIS	900 D Ranger 4x4 Diesel	F	11
POLARIS	800 Ranger RZR-4	F	10-11
POLARIS	800 Ranger Crew	F&R	10-14
POLARIS	900 Ranger	F&R	10-15



65.5X44.8X12mm

RMK-0156

APPLICATION

YAMAHA	YFM 660;	R	02-08 06-07
CF MOTO	CF500	R	14-15
CF MOTO	CF 625-B/C X6 Terralander	R	10-14
CF MOTO	CF 800-2 Terralander	R	14-15
GOES	F 520 F	R	07-13
GOES	525 Max	R	07-12
GOES	G 625i(ALL MODELS)	R	12



94.4X32 X7.8mm

RMO-0160

**RMK-0160
RMS-0160**

APPLICATION

YAMAHA	YZ 125 X/Y/Z (2T)	F	08-15
YAMAHA	YZ 250 X/Y/Z (2T)	F	08-15
YAMAHA	YZ 250 FW/FX/FY/FZ (4T)	F	07-15
YAMAHA	YZ 450 FX/FY/FZ;	F	08-15



65.7X36 X11mm

RMO-0157

**RMK-0157
RMS-0157**

APPLICATION

KAWASAKI	KX 250 F	R	06-15
YAMAHA	YZ 250	R	03-15
YAMAHA	WR 250	R	03-15
APRILIA	SXV 450/550 Supermotard	R	06-10
BETA	RR250	R	05-15
TM	MX85/MX250	R	05-08
TM	EN250	R	05-08



94X47 X8.6mm

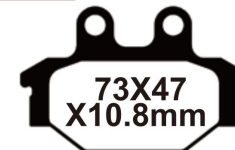

73X47 X10.8mm

RMO-0161

APPLICATION

ADLY	Crossroad 300 Sentinel Quad	F	08-09
ADLY	Canyon 280 Quad	F	08-09
KYMCO	UXV 500 4x4 (Side x Side) (U10000)	F	08-10
KYMCO	MXU 250	F	04-11
KYMCO	UXV 500	F&R	08-14
SYM	Outlander 300 S	F&R	07-08
SYM	Quadraider 600 LE (Quad)	F&R	10
YAMAHA	YZF-R125	R	08-17

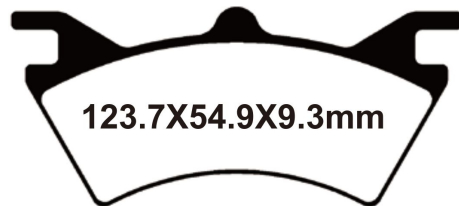

123.7X54.9X9.3mm

RMK-0158

APPLICATION

POLARIS	Sportsman 6x6	R	00-08
POLARIS	PTV (6x6)	R	00-08
POLARIS	PPS/PTV 6x6	R	10
POLARIS	PTV 6x6	R	03
POLARIS	Series 10	R	10
POLARIS	PPS LUH 6x6	R	02



44.2X55.6 X9.6mm

RMO-0162

APPLICATION

NORTON	850 Mk V Commando Roadster	F&R	73
--------	----------------------------	-----	----

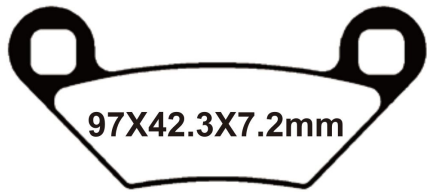

97X42.3X7.2mm

RMK -0163

APPLICATION

POLARIS	550 Sportsman XP	F&R	09-14
POLARIS	850 XP Sportsman	F&R	09-13
POLARIS	1000 Scrambler	F&R	15
POLARIS	Forest	F&R	15



81.8X39
X10mm



81.8X38.5
X10mm

RMK -0167

APPLICATION

HONDA	TRX 500	F	05-14
HONDA	TRX 680	F	06-15
HONDA	TRX 700	R	08-11

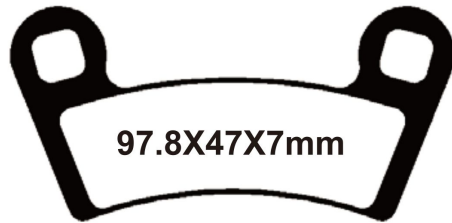

97.8X47X7mm

RMK -0164

APPLICATION

POLARIS	450 S Outlaw	F	08
POLARIS	525 Outlaw IRS	F	08-10
POLARIS	POLARIS RZR 800	F	08-12



75X54X10mm

RMO-0168

RMK -0168

APPLICATION

YAMAHA	FZR 600	F	90-99
YAMAHA	TDM 850	F	96-01
YAMAHA	FZR 1000	F	90-91
YAMAHA	V-MAX12	F	93-03
YAMAHA	FJ 1200 A	F	92-93
MZ	850 KB	F	95

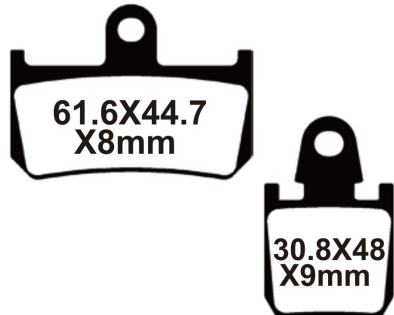

61.6X44.7
X8mm

30.8X48
X9mm

RMK -0165

APPLICATION

YAMAHA	YZF R1	F	07-14
YAMAHA	MT-01	F	07-09
YAMAHA	VMX 1700 V-Max	F	09-14
YAMAHA	MT-01S	F	09

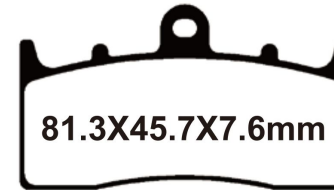

81.3X45.7X7.6mm

RMK -0169

APPLICATION

BMW	R850	F	03-06
BMW	R 1100 S (with integral ABS)	F	00-06
BMW	K 1200 R (K27/0378) Tokico Calliper	F	06-11
BMW	K 1300 R Dynamic	F	11-13
BMW	R 1200 R Classic	F	11-12
BMW	K 1300 R	F	09-12
KAWASAKI	ZRX 400 (ZR 400 E4-E7)	F	98-01



43.3X25.5
X8mm

RMK -0166

APPLICATION

ARCTIC CAT UTILITY	400 2x4/4x4 (FIS) Aut.(Man.Hand Brake)	F	03-04
ARCTIC CAT UTILITY	250 2x4 (Man. Hand Brake)	F	99-
ARCTIC CAT UTILITY	300 4x4 (Man. Hand Brake) 98 -	F	98-
ARCTIC CAT UTILITY	400 TBX 4x4 (Man. Hand Brake) 04	R	04

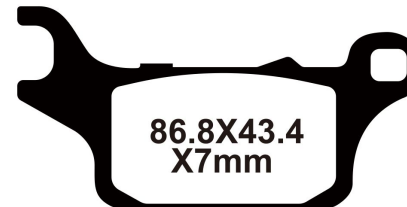

86.8X43.4
X7mm

RMO-0170

APPLICATION

HONDA	CLICK V2 125/150	F	
-------	------------------	---	--

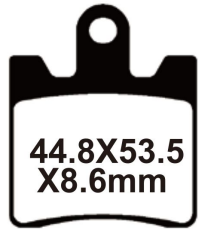

RMO-0171				
APPLICATION				
DAELIM	S3 125	F	11-14	
DAELIM	SL125	F	13-14	
DAELIM	SQ 125	F	08-11	
KAWASAKI	SC 250;	F	02	
SUZUKI	AN 250	F	98-06	
SUZUKI	SQ 125	F	08-11	
SYM	GT 500	F	04	

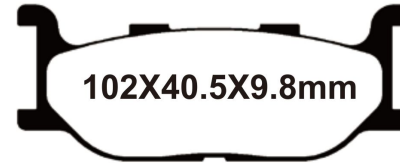

RMK-0175				
APPLICATION				
YAMAHA	SR 400	F	14	
YAMAHA	XP 400	F	05-13	
YAMAHA	XVS 400	F	96-15	
YAMAHA	R T-Max	F	01-03	
YAMAHA	XVS 650	F	97-07	
YAMAHA	XJ 900 S	F	95-03	
YAMAHA	XVS 950	F	14-15	



RMK-0172				
APPLICATION				
YAMAHA	FZR250	F	87	
YAMAHA	TZR 250	F	87	
YAMAHA	SRX 400	F	90-96	
YAMAHA	TRX850	F	96-99	
YAMAHA	FJ 1200	F	89-92	
YAMAHA	XJR 1200	F	95-98	
YAMAHA	XVZ 13	F	96-00	

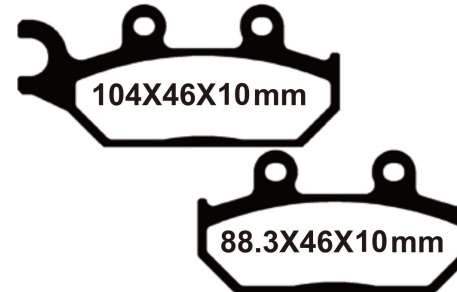

RMO-0176				
RMK-0176				
APPLICATION				
YAMAHA	XT 600 E	F	90-95	
YAMAHA	XTZ 660"Tenere"	F	91-98	



RMK-0173				
APPLICATION				
GO KART	Intrepid ant.			

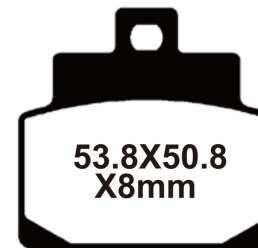

RMO-0177				
APPLICATION				
APRILIA	Scarabeo 100 (2T)	F	00	
APRILIA	Scarabeo 100 (4T) (SA000/VA000)	F	01-09	
APRILIA	Habana 125	F	00-02	
APRILIA	Mojito/Mojito Custom 125	F	03-12	

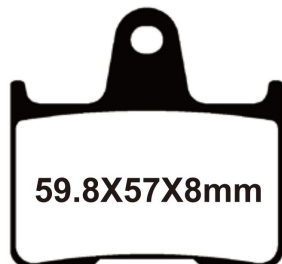

RMK-0174				
APPLICATION				
HONDA	VT 750 C2SA/C25B Shadow	R	10-12	
KAWASAKI	GTR 1400	R	06-19	
KAWASAKI	ZZR 1400	R	06-19	
SUZUKI	GSXR 600	R	04-05	
SUZUKI	GSF 650	R	05-06	
SUZUKI	GSX 1400	R	02-07	

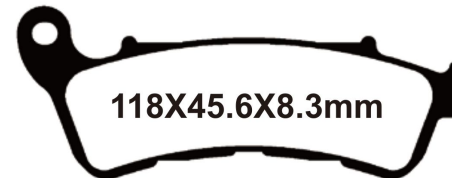

RMO-0178				
APPLICATION				
HONDA	FES 125150	F	07-15	
HONDA	SH 125	F	09-13	
HONDA	SW-T 400	F	09-14	
HONDA	CBF 600	F	08-12	
HONDA	NC 700	F	14	
SUZUKI	UX 125	F	08-14	
SUZUKI	C 1800 RT	F	08-13	

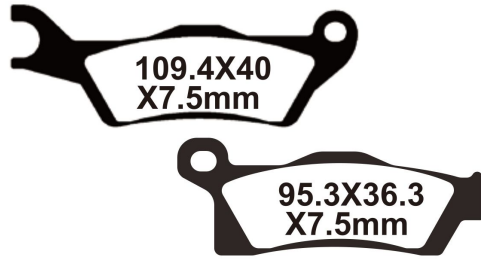

RMK-0179			
APPLICATION			
CAN AM	Outlander 500/650/800/1000	F(Right) &R	13-15
CAN AM	Outlander Max 500 4x4	F(Right) &R	13
CAN AM	Outlander 1000 4x4	F(Right) &R	13

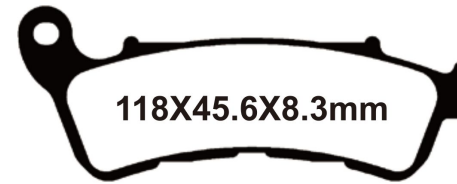

RMO-0182			
APPLICATION			
HONDA	CBR250 RA ABS	F	11-14
HONDA	CBR 250 RA ABS Special edition	F	12-13
SUZUKI	VLR 1800 K8/K9/L0/L1/L2/L3/L4	F	08-14

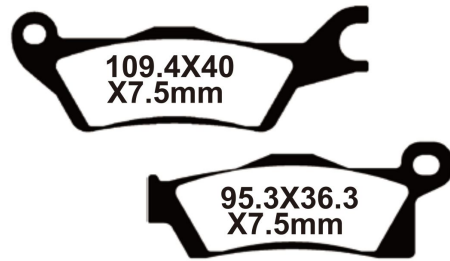

RMK-0179B			
APPLICATION			
CAN AM	Outlander 500/650/800/1000	F(Left) &R(Left)	13-15
CAN AM	Outlander Max 500 4x4	F(Left) &R(Left)	13
CAN AM	Outlander 1000 4x4	F(Left) &R(Left)	13



RMK-0183			
APPLICATION			
GO KART	CRG VENI mini		

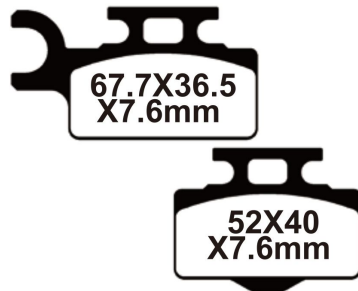

RMO-0180			
APPLICATION			
KAWASAKI	KX 65A1 /A2/A3/A9F/ABF	F	00-15
SUZUKI	RM 65 K3/K4/K5	F	03-05

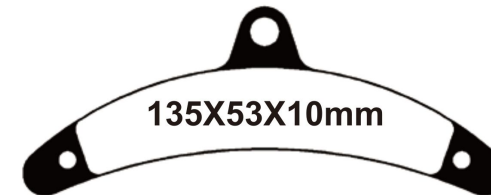

RMK-0184			
APPLICATION			
GO KART	Briel	R	



RMO-0181			
APPLICATION			
KEEWAY	RKV Empire	F	10-15



RMK-0185			
APPLICATION			
GO KART	Briel	F	

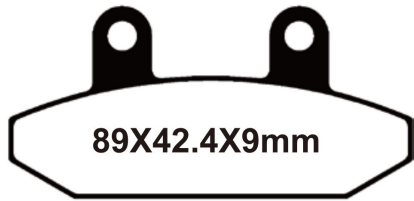

RMO-0186

APPLICATION			
CHINESE ELECTRIC SCOOTER	Xunying 125		

89X42.4X9mm

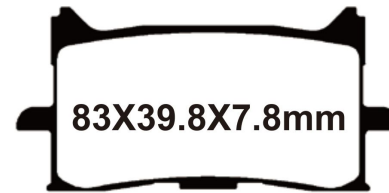

RMK-0190

APPLICATION			
HONDA	CRF1000L Africa Twin	F	16-17
HONDA	CRF1000LD Africa Twin DCT ABS	F	16-17
HONDA	CB 125 R	F	18
HONDA	ADV750 H (X-ADV DCT)	F	17-18

83X39.8X7.8mm



RMO-0187

APPLICATION			
KYMCO	K-XCT 125/people S125/Xciting 250		
KYMCO	people S125		
KYMCO	Xciting 250		

94X36X9.8mm



RMK-0191

APPLICATION			
GO KART	BRM	F	

39.8X45.7 X10mm

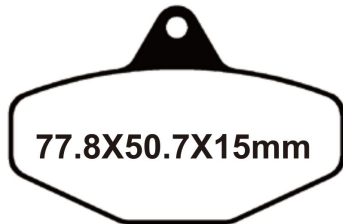

RMK-0188

APPLICATION			
GO KART	CRG VEN08		

77.8X50.7X15mm



RMK-0192

APPLICATION			
GO KART	BRM	R	

61.5X47.5X12mm



RMK-0189

APPLICATION			
BREMBO	X00.C04 60/61		
BREMBO	XA07680 - 2 piston P2 34 Radial Mount		
BREMBO	X99C4 60/61 P4/34 Radial Monobloc 4 pad 108mm spacing		

43X48.6 X9mm



RMO-0193

APPLICATION			
VESPA	PX125	F	98-15

31.8X51.4 X5.5mm



61.8X31.5
X6.5mm

RMO-0194

APPLICATION

HUSQV ARNA	CR 65	F	12
KTM	65 SX	F	04-08
KTM	SX 65	F&R	09-16
KTM	XC 65	F&R	09-10
KTM	85 SX (17"/14" Wheels)	F&R	03-11
KTM	XC 85/105	F&R	08-09
KTM	SX 105	F&R	07-11

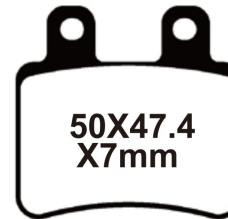

50X47.4
X7mm

RMO-0198

APPLICATION

YAMAHA	XT125R (3D61/3D63/ 13D1/13D3/13D5)	F	05-12
--------	---------------------------------------	---	-------



52X41.5
X7.6mm

RMO-0195

APPLICATION

Electric scooter			
NECO	50	F	

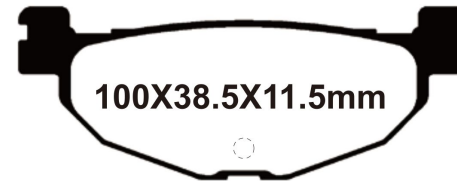

100X38.5X11.5mm

RMK-0199

APPLICATION

YAMAHA	CP 250 (1B71) Maxam/ Morphus R	R	05-06
YAMAHA	YP 400 Majesty (Non ABS)	R	04-13
YAMAHA	XP 500 T-Max (5VU1/ 2/4BS)	R	04-07
YAMAHA	XP 500 T-Max Non ABS Models	R	08-11
YAMAHA	XP 500 T-Max (ABS Models)	R	08-11
YAMAHA	YP 400 Majesty (ABS)	R	07-13

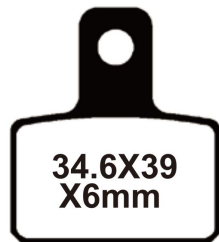

34.6X39
X6mm

RMO-0196

APPLICATION

HUSQ VARNA	CR 50 Junior	F	05
HUSQ VARNA	CR 50 Senior Pro	F	05
HUSQ VARNA	TE 100	F	05

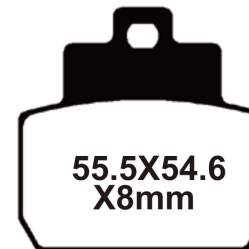

55.5X54.6
X8mm

RMO-0200

APPLICATION

PIAGGIO	MP3 125 (All models)	R	06-09
PIAGGIO	X8 125 ie	R	07
PIAGGIO	X8 150 Street	R	07
PIAGGIO	MP3 250 ie (All models)	R	06-09
PIAGGIO	X8 250 ie	R	05-07
PIAGGIO	X9 250	R	05-07
PIAGGIO	Beverley 500	R	06

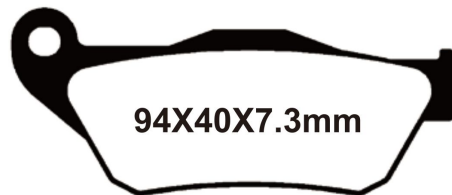

94X40X7.3mm

RMO-0197

APPLICATION

YAMAHA	XP 250 R-X-Max (ICO)	F	05-09
YAMAHA	YP 125 R (X-Max)	F	06-09
MBK	YP 125 Skycruiser	F	06-10

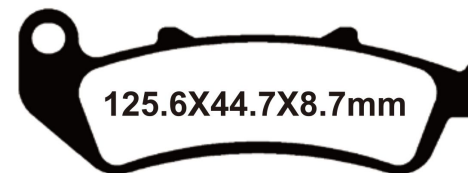

125.6X44.7X8.7mm

RMK-0201

APPLICATION

HONDA	CBR 1000 FP/FR/FS /FT/FV/FW/FX	F&R	93-99
-------	-----------------------------------	-----	-------



69.3X49.6X6.8mm

RMK -0202

APPLICATION

TRIUMPH	Tiger 1050 Sport ABS	F	13-15
---------	----------------------	---	-------

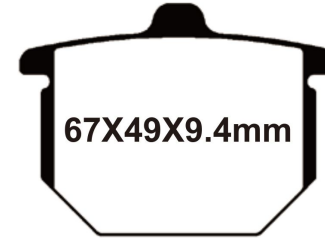

67X49X9.4mm

RMK -0206

APPLICATION

HONDA	CX 500 CA/CB/ZA/B	F	79-81
HONDA	GL 1000 K3/KZ "Goldwing"	F	78-79



70X55X8.5mm

RMK -0203

APPLICATION

SUZUKI	GSF1200SA Bandit	F	97
SUZUKI	Suzuki GSX-R1100	F	89-92
SUZUKI	Suzuki GSX-R750	F	89-93
SUZUKI	Suzuki RF900R	F	94-97
YAMAHA	FZR750R	F	89-90



58X53.5X8.6mm

RMK -0207

APPLICATION

SUZUKI	GSX 1100 FJ/FK/FL/ FM/FN/FP/FR	F	88-94
SUZUKI	RG 400/VS 400	F	94
SUZUKI	VS 600 GLS/GLT/GLV	F	95-97
SUZUKI	VS 700 GLFH/GLPH/ GLFG/GLPG	F	86-87
SUZUKI	GSXR 750 F/G/H	F	85-87
SUZUKI	VS 1400	F&R	87-03
SUZUKI	VL 1500 W/X/Y/K1	F&R	98-01

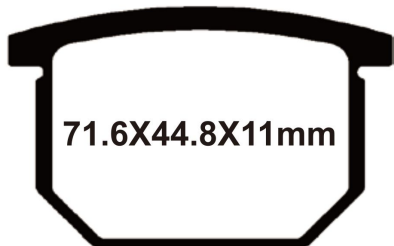

71.6X44.8X11mm

RMK -0204

APPLICATION

SUZUKI	GS 550 ET/EX/EZ/LT/ LX/MX/MZ 80-84 F	F	81-83
SUZUKI	GR 650 D/XD Tempter	F	83
SUZUKI	GS 650 GTX/GTZ/GTD /GX/GZ	F	81-83
SUZUKI	GSX 750 S-2/S-2C (GS 75X-114747-) Katana	F	84
SUZUKI	XN 85 Turbo	F	83
SUZUKI	GS 1000 ET	F	81
SUZUKI	GSX 1100 ET/EX/EZ/ ESD	F	80-83

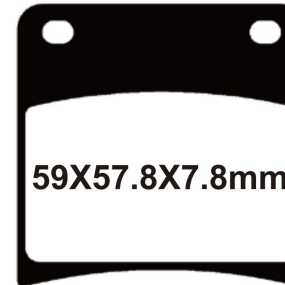

59X57.8X7.8mm

RMK -0208

APPLICATION

SUZUKI	GSX 1100 GM/GN;	R	91-93
SUZUKI	VX 800 L/M/N/P/R/T	R	90-93
SUZUKI	GW 250 L3 Inazuma		



67X49.6X11mm

RMK -0205

APPLICATION

YAMAHA	XS 250 D/E	F	79-81
YAMAHA	SR 500	F	78-82
YAMAHA	XJ 650	F	80-84
YAMAHA	XS 650 SE	F&R	79-80
YAMAHA	XS 750	F&R	77-79
YAMAHA	XS 850	F&R	80
YAMAHA	XV 1000 TRI	F	81

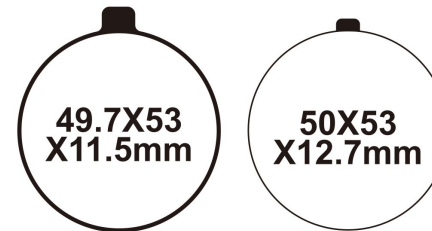

49.7X53 X11.5mm

50X53 X12.7mm

RMO-0209

APPLICATION

SUZUKI	GT 125 C/EC/EN	F	78-79
SUZUKI	GT 200 EN/EX "X5"	F	79-82
SUZUKI	GT 250 EN/ET/EX "X7"	F	78-81
SUZUKI	GS 550 DB/DC/EC/EN	F	77-79
SUZUKI	GS 850 GN/GT/GX	F	79-81
SUZUKI	GS 1000 HC/EC/EN/SN	F	78-80

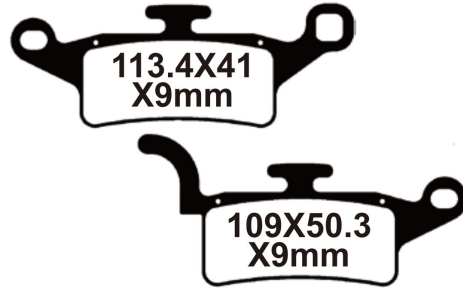

RMO-0210

APPLICATION			
MBK	YW 125Z		
YAMAHA	125 XENTER		
BWS	125		

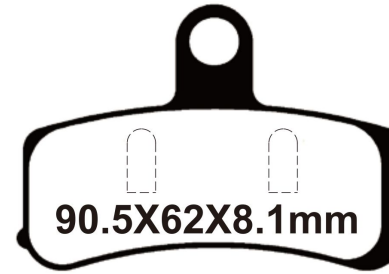

RMK-0213

APPLICATION			
HARLEY DAVIDSON	FXDC Super Glide Custom	F	08-13
HARLEY DAVIDSON	Dyna Wide Glide (Spoke wheels)	F	10-12
HARLEY DAVIDSON	FLSTN Softail Deluxe	F	08-13
HARLEY DAVIDSON	FLD Switchback	F	12-13
HARLEY DAVIDSON	FLSTFB Fat Boy Lo Softail	F	10-13
HARLEY DAVIDSON	Softail FXS Blackline	F	11-13

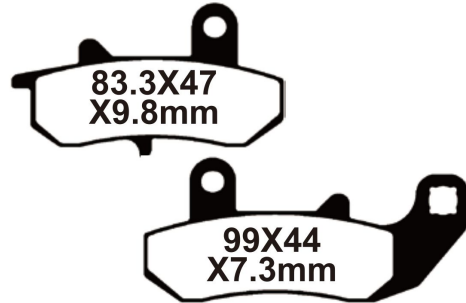

RMO-0211

APPLICATION			
SUZUKI	RG 125	R	92-94
SUZUKI	DR 600 RK	R	89
SUZUKI	DR 650 RER/RES	R	94-95
SUZUKI	DR 750 SK	R	89
SUZUKI	DR 800 SL SK	R	90
YAMAHA	DTZ 125 Tenere/Tenere	R	89-90
YAMAHA	DT 125 Chesterfield Scout	R	89-90



RMO-0214
RMK-0214

APPLICATION			
APRILIA	SVX 450/550 Supermotard	F	06-13
APRILIA	Pegaso 650 Factory	F	06-08
HUSABERG	FS 450 E	F	06-08
HUSABERG	FS 550 E Supermoto	F	05-07
HUSABERG	FS 650 E Supermoto	F	05-08
KTM	SMR 450	F	05-06
KTM	SMR 650 Supermoto	F	06



RMK-0212

APPLICATION			
HONDA	GB 250 J/L/P/S/V	F	89-97
HONDA	NX 500 J/K/L/M/N/P/R/S/T	F	92-96
HONDA	XL 600 VM/VN/VP	F	91-93
HONDA	VT 600 C/N	F	93
HONDA	GL1500	F	88-00
CAGIVA	Canyon 500	F	96-00
CAGIVA	E. 750 Elefant	F	93-95



RMK-0215

APPLICATION			
SUZUKI	GSX250S KATANA	R	86
SUZUKI	LS650F savage	R	90-98
SUZUKI	GSX1100S Katana	R	00



RMK-0212A

APPLICATION			
	AN 250 SkywaveTypeM	R	07-08
	AN 400	R	07-13
	AN 650 ZL3 Burgman	R	13



RMK-0216

APPLICATION			
SYM	Max	F	11-13
SYM	400i (Inc ABS)	F	11-14



83.1X48
X11.9mm

RMK-0217

APPLICATION

SYM	Max	R	11-15
SYM	400i (Inc ABS)	R	11-16

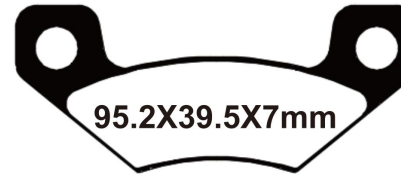

95.2X39.5X7mm

RMK-0220C

APPLICATION

JOHN DEERE GATOR	HPX All models	F&R	04-05
JOHN DEERE GATOR	HPX 4x4 Gator (Petrol) Parking brake	F&R	10-11
JOHN DEERE GATOR	HPX 4x4/4x4 Trail Gator (Petrol)	F&R	10-11
JOHN DEERE GATOR	HPX 4x4 Gator (Diesel)	F&R	10
CAN AM	DS 450 (2x4/EFI)	R	08-12
CAN AM	DS 450 XXC/XXM	R	10-12



83.1X48
X11.9mm

RMK-0217A

APPLICATION

SYM	Max Sym 400i (Inc ABS)	R	11-13
-----	------------------------	---	-------

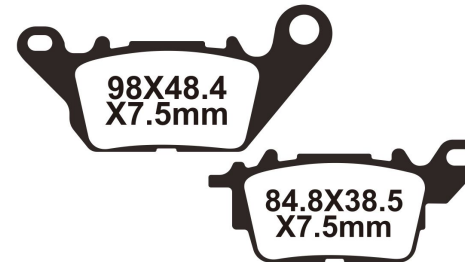

98X48.4
X7.5mm

84.8X38.5
X7.5mm

RMO-0221

APPLICATION

YAMAHA	N- Max - see GPD 125 A	F	15-18
YAMAHA	N-Max 150 see DPD 150 A	F	15-17
YAMAHA	LTS 125-C D'eight	F	17-18

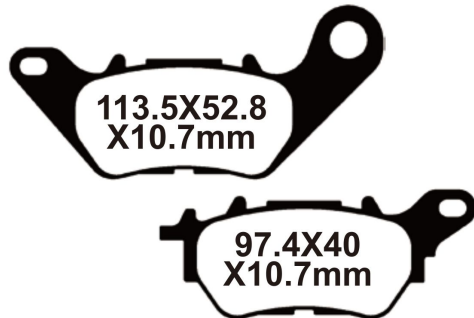

113.5X52.8
X10.7mm

97.4X40
X10.7mm

RMK-0218

APPLICATION

YAMAHA	R25	R	
--------	-----	---	--



64.7X41.2
X9mm

RMO-0222

APPLICATION

VELOREX	150 CROSS		
---------	-----------	--	--

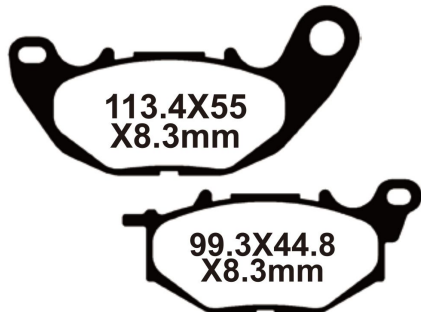

113.4X55
X8.3mm

99.3X44.8
X8.3mm

RMK-0219

APPLICATION

YAMAHA	R25	F	
--------	-----	---	--



127.2X52.2
X8mm

RMK-0223

APPLICATION

HARLEY DAVIDSON	FXDWG Dyna Wide Glide (Spoke wheels)	R	08-15
HARLEY DAVIDSON	FXDC Super Glide Custom	R	08-13
HARLEY DAVIDSON	FXDB Street Bob	R	08-13
HARLEY DAVIDSON	FDXL Low Rider	R	08-09
HARLEY DAVIDSON	FXDF Fat Bob	R	08-13
HARLEY DAVIDSON	FXSTB Night Train	R	08-09
HARLEY DAVIDSON	FLS Softail Slim	R	12-13



71X35.8X9mm

RMO-0224

APPLICATION

YAMAHA	XT 350 B-H	R	91-96
YAMAHA	125 Apache	F	90-
GILERA	RC 125 Top Rally	F	90-
GILERA	RC 600 Top Rally	F	90-



69.7X45.7X8.7mm

RMO-0228

APPLICATION

KTM	Duke 125 (4T)	F	11-13
KTM	Duke 200 (4T)	F	12-13
KTM	Duke 390	F	13



65X43.8X12mm

RMK-0225

APPLICATION

GO KART	Intrepid post		
---------	---------------	--	--



44.6X34.9
X5mm

RMO-0229

APPLICATION

	Chinese electric scooter		
--	--------------------------	--	--

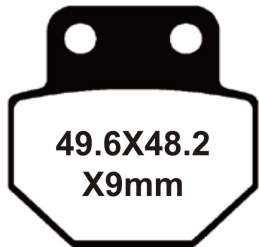

49.6X48.2
X9mm

RMO-0226

APPLICATION

	Chinese SCOOTER		
	Chinese Tricycle		

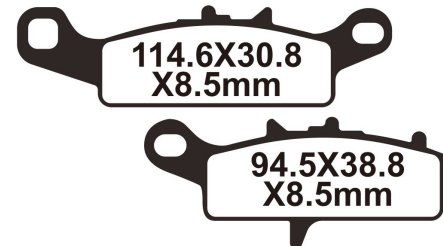

114.6X30.8
X8.5mm

94.5X38.8
X8.5mm

RMO-0230

APPLICATION

YAMAHA	RS Zero/RSZ/JOG50	F	14
--------	-------------------	---	----



74.8X51.7X7mm

RMO-0227

APPLICATION

ITALIKA	Tc200	F	
ITALIKA	Tc250	F	
ITALIKA	Rc200	F	



99.2X42.1
X8mm



83.5X41.5
X8.9mm

RMO-0231

APPLICATION

	NEW CUXI115		
--	-------------	--	--



35.5X49.5
X6.5mm

RMO-0232

APPLICATION

PIAGGIO	Sfera RST 50	F	95-97
PIAGGIO	Sfera 125	F	95-97



87.4X48X9.3mm

RMK-0236

APPLICATION

	Dorsoduro 750 (ABS)	F	08-13
--	---------------------	---	-------



81X42X8.3mm

RMO-0233

APPLICATION

HONDA	CR125 RE/RF/RG	R	84-86
HONDA	MTX125 RWE/RWF/RWH/RWL	R	85-95
HONDA	XL125 RF/RH	R	85-86
HONDA	FTR223 (MC34) Y2/A2	R	00-02
HONDA	XLR250 R (MD22)	R	88-90
HONDA	TRX250 RG/RH/RJ/RK	R	86-89
HONDA	CR500 RE/RF/RG	R	84-96

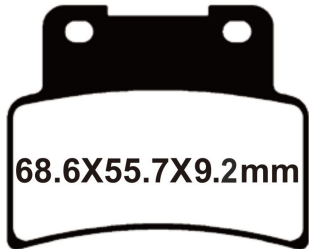

68.6X55.7X9.2mm

RMK-0237

APPLICATION

APRILIA	RS 125 (Radial Caliper) 2T	F	06-13
APRILIA	Shiver 750 GT	F	09-10
APRILIA	hiver 750	F	07-10



41.1X42.5
X7.3mm

RMO-0234

APPLICATION

KTM/HUSQVARNA	85 SX 17/14/85 SX 19/16/TC 85		
---------------	-------------------------------	--	--

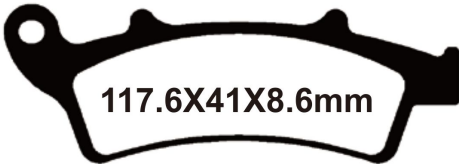

117.6X41X8.6mm

RMK-0238

APPLICATION

APRILIA	Atlantic 300/Scarabeo 250 ie	F	03-05
APRILIA	Atlantic Sprint 400	F	05-08
KYMCO	K-XCT 125/PEUGEOT LOOXOR 125/150	F	10-11
PIAGGIO	Beverly 300 Sport Touring (330cc/4T)	F	11-13



59X40X7.5mm

RMO-0235

APPLICATION

HUSQVARNA	CR 65	R	11-13
KTM	SX 85 (17"/14" wheels)	R	11-13
KTM	SX 85 (19"/16" wheels)	R	11-13
KTM	350 Freeride (4T)	R	12-13
KTM	Freeride E (Electric)	R	12



61.5X47.1X7.3mm

RMK-0239

APPLICATION

BUELL	1125CR	F	09-10
BUELL	XB12 SCG Lightning	F	09-10
BUELL	XB12 SS Lightning	F	09-10



64.8X46.1X10mm

RMK -0240

APPLICATION

GO KART	CRG ven 04	R	
---------	------------	---	--



75X39.5
X10.8mm

RMK -0244

APPLICATION

HONDA	TRX 420 FA9/FAA	R	09-10
HONDA	TRX 420 FPA9/FPAA	R	09-10
HONDA	TRX 450	R	04-09
HONDA	TRX 650	R	03-05
HONDA	TRX 680	R	06-10

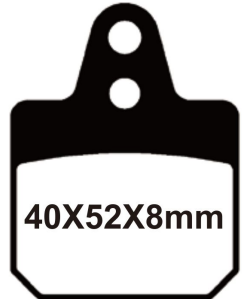

40X52X8mm

RMK -0241

APPLICATION

GO KART BIREL	Brake calipers RR-125x4-H16	R	
GO KART BIREL	Caliper I25x2 RR-brake H3	R	
GO KART BIREL	Caliper RR-125x2 Ant-H12.	R	



67X51.5X7.5mm

RMK -0245

APPLICATION

HONDA	CRF250L CRF 250L	F	13-17
CAN AM	DS 450(2x4/EFI)	F	08-12
CAN AM	DS 450X(2x4/EFI)	F	08-09
CAN AM	DS 450 Xx4/Xxm	F	10-12
CAN AM	WK BIKES WK 400 Trail	F	15-17



41.6X42.6
X8mm

RMK -0242

APPLICATION

GO KART CRG	CRG V04-V06- Mini New Age	F	
----------------	------------------------------	---	--



94X33X8mm

RMO-0246

APPLICATION

CSC	Cyclone 250	F	15-16
FANTIC	50	F	



55.8X60X10mm

RMK -0243

APPLICATION

GO KART BIREL	Art	R	
------------------	-----	---	--



155.2X52.9X7.5mm

RMK -0247

APPLICATION

POLARIS	RZR XP Turbo 2016 F/ RZR XP 4 Turbo	F	16
---------	----------------------------------------	---	----



47X38.5
X8mm

RMO-0248

APPLICATION

Chinese SCOOTER

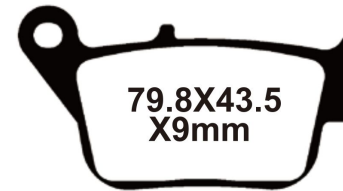

79.8X43.5
X9mm

RMO-0252

APPLICATION

YAMAHA	X-MAX 250 (2DLNon ABS/Heng Tong R Caliper)	R	14-16
YAMAHA	YP250 R X-MAX YP250 R X-MAX (2DLNon ABS /Heng Tong R/Caliper)	R	14-16



94X36X10mm

RMO-0249

APPLICATION

SYM	RV200	R	12-14
SYM	RV250 (Im 250w)	R	07-12

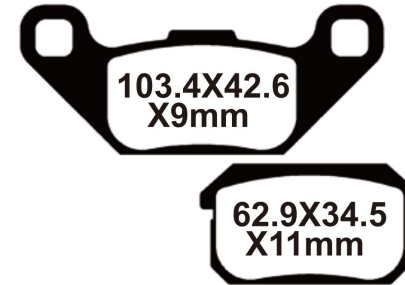

103.4X42.6
X9mm

62.9X34.5
X11mm

RMO-0253

APPLICATION

QUADZILLA	CVT 150 E	R	10-11
PGO	BR-200 Bugrider	R	07-12
PGO	BR 250 E Bugrider	R	05-12
PGO	250 Bug R	R	
ADLY	300 RS Quad	R	07-08



85.1X51X8mm

RMK-0250

APPLICATION

CAN-AM	Spyder F3 /Ducati 899 Panigale, Scrambler	F	13
BMW	R1200GS	F	13
APRILIA	Caponord 1200 Tuono V4R	F	13



45.9X52.5
X6.7mm

RMO-0254

APPLICATION

YAMAHA	EW 50 STUNT	F	01-03
YAMAHA	EW 50 Slider	F	00-05
YAMAHA	NS 50 Aerox R (1PH1) 13 R	R	13
YAMAHA	NS 50 Aerox R Naked (1PL1) 13 R	R	13
YAMAHA	YQ 50 Aerox R/Aerox R	R	97-13
MBK	YQ 50 Nitro Naked	R	06-10

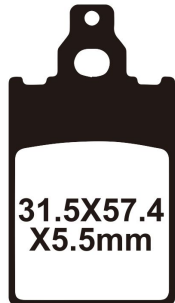

31.5X57.4
X5.5mm

RMO-0251

APPLICATION

BETA	TR34 125/260	R	86-88
GARELLI	Sahel 50/80	F	91-
PIAGGIO	Free 50 (Disc Model)	F	95-00
PIAGGIO	Free Delivery 50	F	00-01



52X40.4X8mm

RMO-0255

APPLICATION

Chinese SCOOTER



RMK-0256

APPLICATION			
TONY KART	Go-Kart ant. 2015	R	15

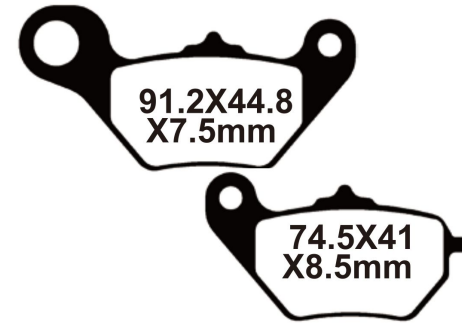

RMO-0260

APPLICATION			
YADI	Chinese SCOOTER		

RMO-0261

APPLICATION			
	Chinese SCOOTER		

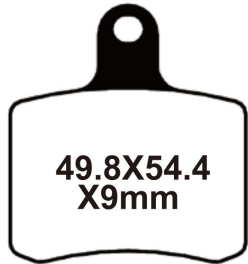

RMK-0257

APPLICATION			
TONY KART	go-karts new type OTK BSD	R	15



RMK-0263

APPLICATION			
GO KART			



RMO-0258

APPLICATION			
	Chinese SCOOTER		



RMO-0259

APPLICATION			
	Chinese SCOOTER		

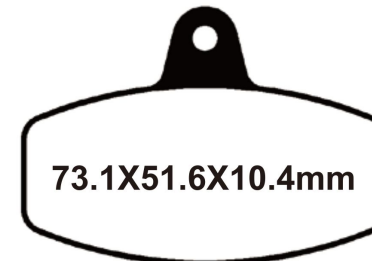

RMK-0264

APPLICATION			
GO KART			

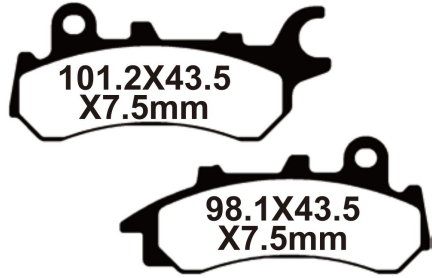

RMO-0265

APPLICATION			
HONDA	TITAN 150/160		17-18
HONDA	CBS CG 160 CBS COMB BRAKE		18



RMK-0268

APPLICATION			
POLARIS	Ranger RZR 170	F	09-11

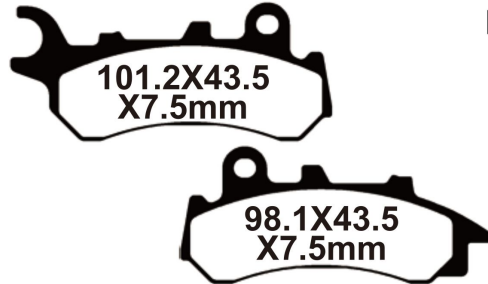

RMO-0265B

APPLICATION			
HONDA	PCX-2019		19

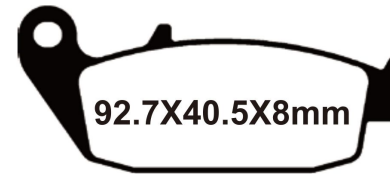

RMO-0269

APPLICATION			
TVS	APACHE RTR 180 TRAS		

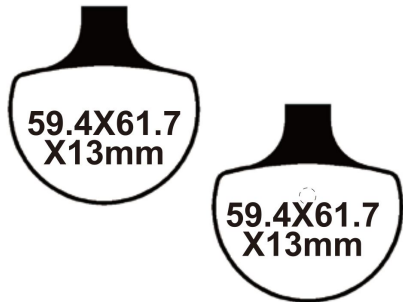

RMK-0266

APPLICATION			
HARLEY DAVIDSON	FLT/FLHT/FLHTCI	F	84-99
HARLEY DAVIDSON	FLHR/FLHRCI	F	94-99
HARLEY DAVIDSON	FXSTS/FXSTSj	F	00-05
HARLEY DAVIDSON	FLSTS Heritage Springer	F	00-03
HARLEY DAVIDSON	FLSTSC/FLSTSCi Springer Softail Classic	F	06-07
HARLEY DAVIDSON	FLSTSB Softail Cross Bones	F	08-11

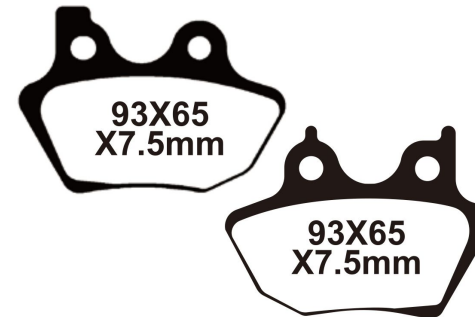

RMK-0270

APPLICATION			
HARLEY DAVIDSON	Most models	F&R	03-11



RMK-0267

APPLICATION			
HARLEY DAVIDSON	FXST/FXSTB/FXSTC/ FXSTS/FLST/FLSTC/ FLSTF/FLST/ FLSTN Late	R	87-99
HARLEY DAVIDSON	XL/XLH/XLCH/XLS/ XLX Late	R	87-99
HARLEY DAVIDSON	FXD/FXDL/FXDWG/ FXR/FXRS/FXRT/ FXRD/FXLR Late	R	87-99

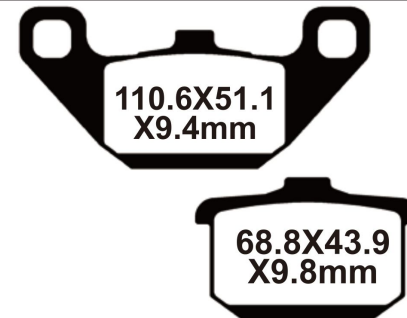

RMO-0271

APPLICATION			
KAWASAKI	EL 250 'Eliminator'	F	87-89
KAWASAKI	EL 250 D1-D5	F	90-94
KAWASAKI	EL 252 (EL 250 F2/F3/ F5/F6)	F	96-03
KAWASAKI	ER 250 B1-B3 (Z250T Scorpion)	F	83-88
KAWASAKI	GPZ 250 R (EX 250 E)	F&R	86

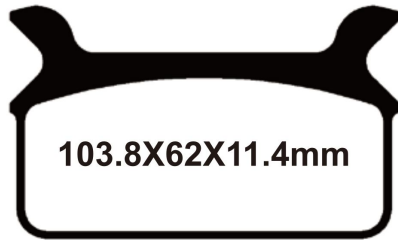

103.8X62X11.4mm

RMK -0272

APPLICATION

HARLEY DAVIDSON	FLT/FLHT/FLHTCI	R	86-99
HARLEY DAVIDSON	FLHR/FLHRCI	R	94-99



64.6X42
X7.3mm

RMO-0276

APPLICATION

--	--	--	--



104.5X40.5
X10.8mm

RMK -0273

APPLICATION

SUZUKI	RAIDER R150(FI)		
--------	-----------------	--	--

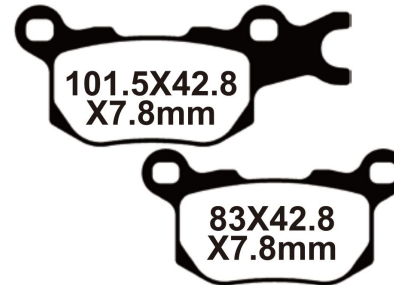

101.5X42.8
X7.8mm

83X42.8
X7.8mm

RMK -0277

APPLICATION

CAN-AM	Defender 799cc	R Left	16
CAN-AM	Defender DPS 799cc	R Left	16
CAN-AM	Defender XT 799cc	R Left	16
CAN-AM	Defender XT Cab 799cc	R Left	16
CAN-AM	Defender 976cc	R Left	16
CAN-AM	Defender DPS 976cc	R Left	16
CAN-AM	Defender XT Cab 976cc	R Left	16

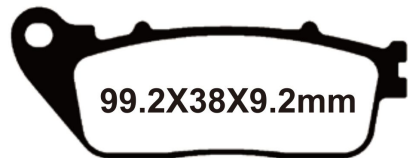

99.2X38X9.2mm

RMK -0274

APPLICATION

HONDA	VFR 800 XC Crossrunner 800	R	12-13
HONDA	CB 1000 R9/RA/RB/RC Non ABS Model	R	09-13
HONDA	VFR 1200 FA/FB	R	10-13

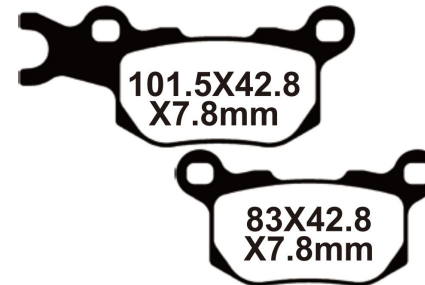

101.5X42.8
X7.8mm

83X42.8
X7.8mm

RMK -0277B

APPLICATION

CAN-AM	Defender 799cc	R Right	16
CAN-AM	Defender DPS 799cc	R Right	16
CAN-AM	Defender XT 799cc	R Right	16
CAN-AM	Defender XT Cab 799cc	R Right	16
CAN-AM	Defender 976cc	R Right	16
CAN-AM	Defender DPS 976cc	R Right	16
CAN-AM	Defender XT Cab 976cc	R Right	16

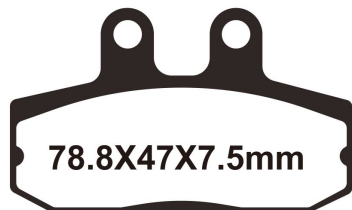

78.8X47X7.5mm

RMK -0275

APPLICATION

APRILIA	Mana 850	R	08-11
APRILIA	Mana 850 GT (ABS Model)	R	09-13
APRILIA	Mana 850 ABS	R	08-13
MOTO GUZZI	V7 Racer 750 (Spoke)	R	12-13
MOTO GUZZI	V7 Special 750 (Spoke wheel)	R	13
MOTO GUZZI	V7 Stone (Cast wheel)	R	12-13
MOTO GUZZI	MOTO MORINI		

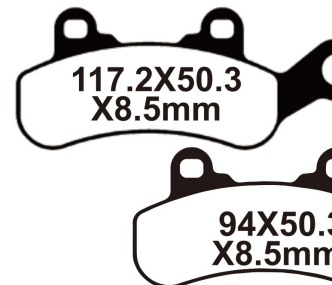

117.2X50.3
X8.5mm

94X50.3
X8.5mm

RMK -0278

APPLICATION

CAN-AM	Maverick X3	F(Left) &R(left)	17
CAN-AM	Maverick X3 MAX TURBO	F(Left) &R(left)	17-18
CAN-AM	Maverick X3 TURBO	F(Left) &R(left)	18
CAN-AM	Maverick X3 MAX TURBO R	F(Left) &R(left)	18
CAN-AM	Maverick X3 TURBO R	F(Left) &R(left)	18

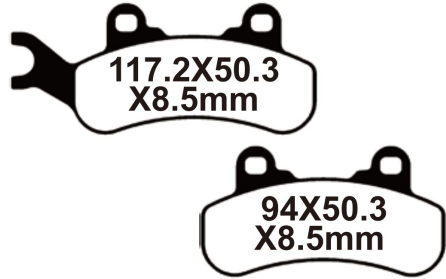

RMK -0278B			
APPLICATION			
CAN-AM	Maverick X3	F(right) &R(right)	17
CAN-AM	Maverick X3 MAX TURBO	F(right) &R(right)	17-18
CAN-AM	Maverick X3 TURBO	F(right) &R(right)	18
CAN-AM	Maverick X3 MAX TURBO R	F(right) &R(right)	18
CAN-AM	Maverick X3 TURBO R	F(right) &R(right)	18

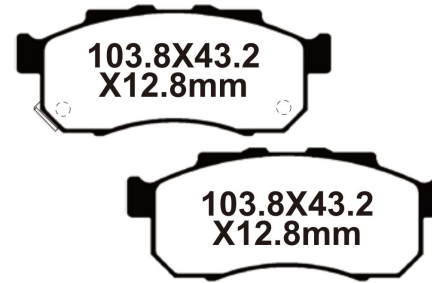

RMK -0280B			
APPLICATION			
HONDA	MUV 700-9 Big Red Side x Side	F Right	09

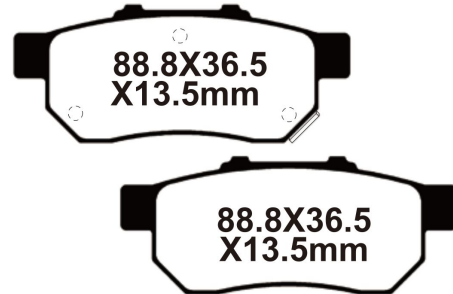

RMK -0279			
APPLICATION			
HONDA	MUV 700-9 Big Red Side x Side	R Left	09

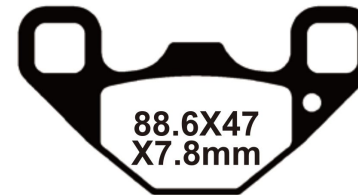

RMK -0281			
APPLICATION			
POLARIS	Ranger RZR 170	R	09-11

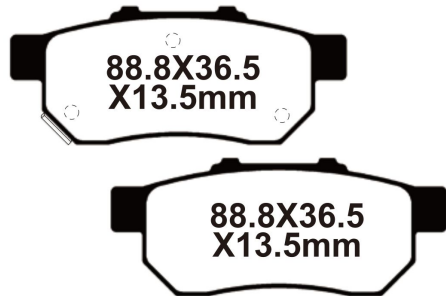

RMK -0279B			
APPLICATION			
HONDA	MUV 700-9 Big Red Side x Side	R Right	09

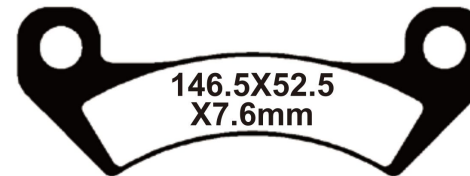

RMK -0282			
APPLICATION			
JOHN DEERE GATOR	XUV 625i 4X4	F	11
JOHN DEERE GATOR	XUV 825i 4X4	F	11
JOHN DEERE GATOR	XUV 855D 4x4 Diesel	F	11

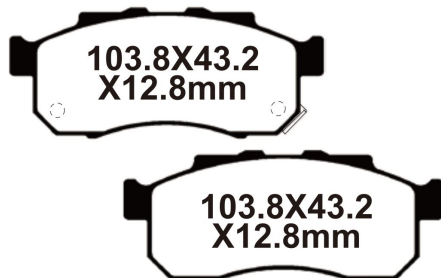

RMK -0280			
APPLICATION			
HONDA	MUV 700-9 Big Red Side x Side	F Left	09

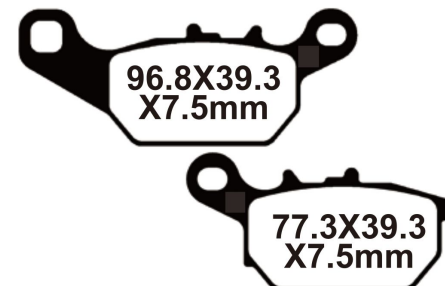

RMK -0283			
APPLICATION			
	YNC		

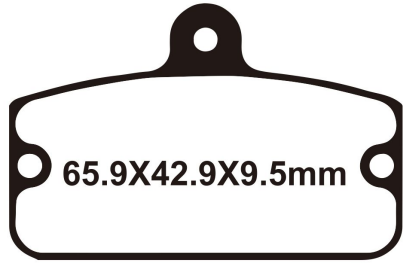

RMK -0284

APPLICATION

GO KART SODI POST

65.9X42.9X9.5mm

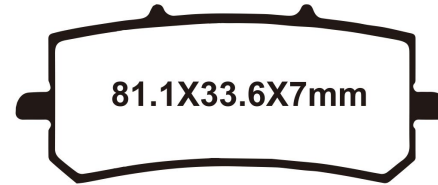

RMK -0288

APPLICATION

CFMOTO CF250NK F

81.1X33.6X7mm



RMK -0285

APPLICATION

GO KART PAROLIN POST

50.8X61.6X15mm



RMK -0289

APPLICATION

GO KAR' CRG POST

92X62.5X16mm



RMK -0286

APPLICATION

GO KART PRAGA ANT

59.8X39.7X10mm

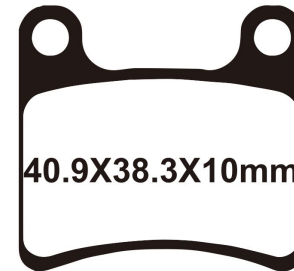

RMK -0290

APPLICATION

GO KART CRG ANT

40.9X38.3X10mm



RMK -0287

APPLICATION

GO KART PRAGA POST

59.8X37.6X12mm



RMK -0291

APPLICATION

GO KART CRG POST

80X46.1X13mm

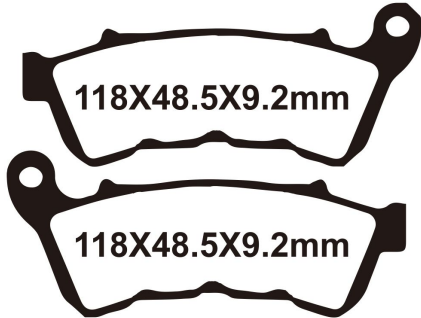

RMK -0292			
APPLICATION			
HARLEY DAVIDSON	Harley-Davidson SuperLow 1200 XLT		14-17
HARLEY DAVIDSON	Sportster Seventy-Two XLV		14-16
HARLEY DAVIDSON	1200 Custom EFI XLC		14-19
HARLEY DAVIDSON	883 SuperLow XLL		14-19
HARLEY DAVIDSON	Sportster Forty-Eight XLX		14-19
HARLEY DAVIDSON	Iron 883 XLN		14-19
HARLEY DAVIDSON	1200 Roadster XLCX		16-19

RMO -0295			
APPLICATION			
KEEWAY	GTX 300 Quad	F	10
QUADZILLA	QZ 300 E4*4	F	09
QUADZILLA	QZ 320 E4*4,325 4*4	F	10-11



RMK -0293			
APPLICATION			
HARLEY DAVIDSON	FLFBS Fat boy 114 18 R/Anniv 18 RT	R	18
HARLEY DAVIDSON	FLHC Heritage Classic/114/114 Anniv.	R	18
HARLEY DAVIDSON	FLSL Softail Slim	R	18
HARLEY DAVIDSON	FXBRS Breakout 114/114 Anniv	R	18-20
HARLEY DAVIDSON	FLDE Deluxe FXBB Street Bob	R	18-20
HARLEY DAVIDSON	FXFB Fat Bob FXBS Fat Bob	R	18-20
HARLEY DAVIDSON	FXLR Low Rider	R	18-20

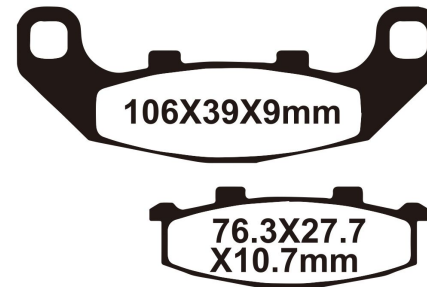

RMO -0296			
APPLICATION			
KAWASAKI	EX 250 F2-F19 D6F/D7F Ninja 250	R	88-07
KAWASAKI	ZR 550 B1/B2/B3 Zephyr	R	90-92
KAWASAKI	GPX 250 R (ZX 250 F2-F9)	R	88-95
KAWASAKI	ZXR 250 C1-C5 (ZX 250 C1-C5)	F	91-95
SUZUKI	RGV 250 M/N/P/R/S/T	R	91-96
SUZUKI	RGV 250 T (RGVR 250 SP VJ23A)	R	96

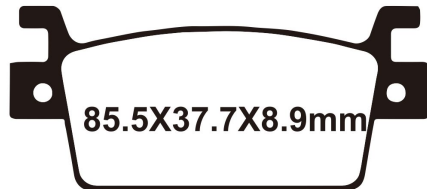

RMK -0294			
APPLICATION			
KYMCO	AK550	R	17-18

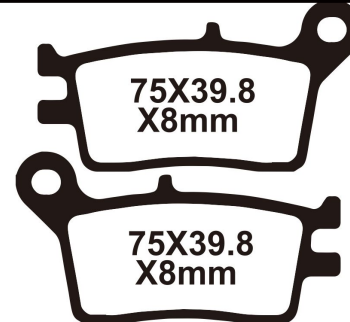

RMO -0297			
APPLICATION			
HONDA	AX-1 (NX 250 J/K/R/R3)	R	89-94
HONDA	CRM 250R(R/K)MK1 MD24 (100001-1008385)	R	89-90
HONDA	RTL 250 S	R	88-89
HONDA	XLR 250 R (MD22)	R	88-90
HONDA	XLR 250 Baja MK2 (MD22)	R	
HONDA	TLM 260	R	89-93

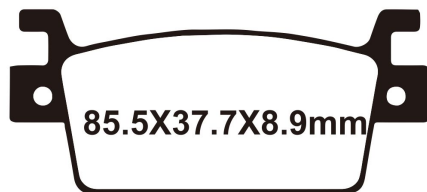

RMK -0294B			
APPLICATION			

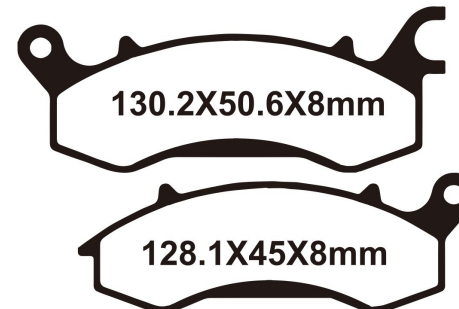

RMO -0298			
APPLICATION			
SYM	CARGO		

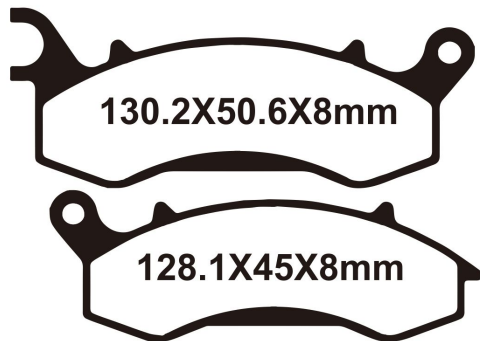

RMO-0298B			
APPLICATION			
LEXMOTO	ZSX-F 125 ZS125-48E-E4	F	16-20
LEXMOTO	ZSX-R 125 ZS125-48F-E4	F	16-20
SINNIS	Hoodlum 125 ZS 125-79	F	17-20
MACBOR	XR1	F	

RMK-0302			
APPLICATION			
YAMAHA	YZZ 1000 R	F	16-21
YAMAHA	YZZ 1000 EPS Special Edition	F	16-21

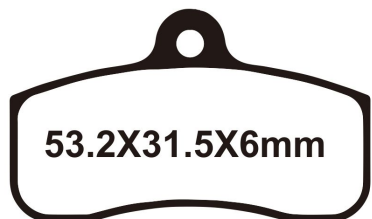

RMK-0299			
APPLICATION			
GO KART			

RMK-0303			
APPLICATION			
KAWASASKI	KRX 1000 Teryx	F	21

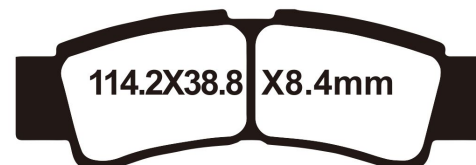

RMK-0300			
APPLICATION			
HAOJUE	CHOPPER 550 EBS		

RMK-0304			
APPLICATION			
YAMAHA	YZZ 1000 R	R	16-21
YAMAHA	YZZ 1000 EPS Special Edition	R	16-21

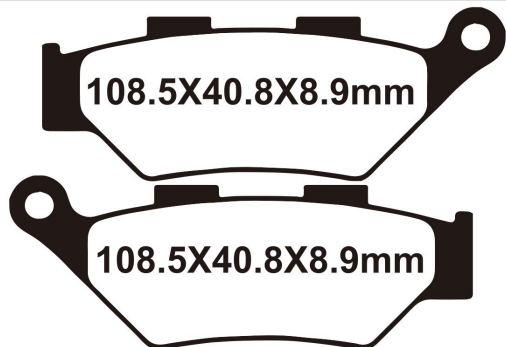
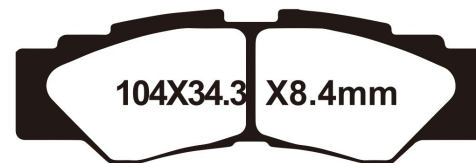

RMO-0301			
RMK-0301			
APPLICATION			
BENELLI	TRK502X	F	

RMK-0305			
APPLICATION			
POLARIS	RZR XP4 Turbo	F	19-20



RMK -0306

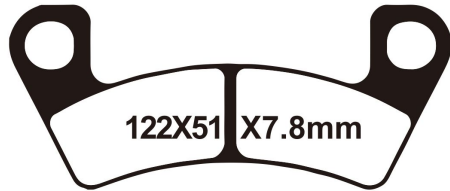

APPLICATION

POLARIS			
---------	--	--	--

RMK -0309

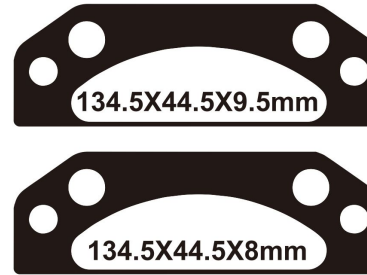

APPLICATION

POLARIS	Various Models 05-16	PARKING	05-16
---------	----------------------	---------	-------

RMK -0307



APPLICATION

CF MOTO	NK250/SR	F	
---------	----------	---	--

RMK -0310



APPLICATION

GO KART			
---------	--	--	--

RMK -0308

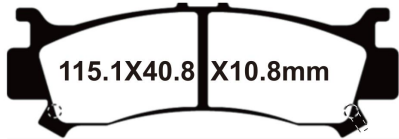

APPLICATION

HONDA	Pioneer 1000 SXS (2 Seater)	F Left	16-21
HONDA	Pioneer 1000 SXS (4 Seater)	F Left	16-21
HONDA	Talon 1000 R	F	19-21
HONDA	Talon 1000 X	F	19-21
HONDA	Talon 1000 X-4	F	19-21

RMK -0311



APPLICATION

	RTM		
--	-----	--	--

RMK -0308B

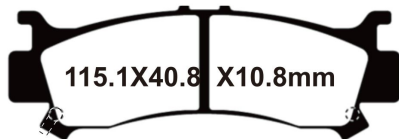

APPLICATION

HONDA	Pioneer 1000 SXS (2 Seater)	F Left	16-21
HONDA	Pioneer 1000 SXS (4 Seater)	F Left	16-21
HONDA	Talon 1000 R	F	19-21
HONDA	Talon 1000 X	F	19-21
HONDA	Talon 1000 X-4	F	19-21

RMK -0312

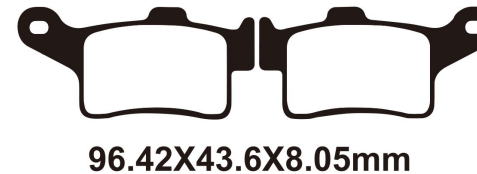

APPLICATION

CAN AM	Spyder RS /RS-S (Brembo Caliper)	R	13-16
CAN AM	Spyder RT (3 Cyl Eng /6 Speed)	R	13-21
CAN AM	Spyder ST (Srembo Calipers)	R	13-16
CAN AM	Spyder F3 (SE6/SM6)	R	13-16
CAN AM	Spyder F3 LTD	R	16-21
CAN AM	Spyder F3-T	R	16-21
HARLEY DAVIDSON	FLHTCUTGSE CVO Tri Glide	R	21



A:81.8X38.8X10.3mm
B:81.8X38.8X10.3mm

RMK -0313

APPLICATION			
HONDA	Pioneer 1000 SXS (2 Seater)	R Left	16-21
HONDA	Pioneer 1000 SXS (4 Seater)	R Left	16-21
HONDA	Talon 1000 R	R	19-21
HONDA	Talon 1000 X	R	19-21
HONDA	Talon 1000 X-4	R	19-21

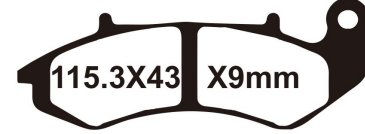
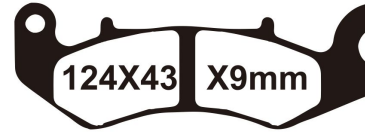

RMO-0316B

APPLICATION			
GENERIC KSR	Demonio 50/125	F	17-18
GENERIC KSR	Classic 125	F	17-18
GENERIC KSR	Code 125	F	17-20
GENERIC KSR	GRS 125	F	17-20
GENERIC KSR	TR 125 SM (4T) TR 125 X/TW 125 SM	F	17-18
GENERIC KSR	Race 2 125 GT (4T)	F	18
GENERIC KSR	Sirion 125 (4T/ Rear Disc Model)	F	18-20



A:81.8X38.8X10.3mm
B:81.8X38.8X10.3mm

RMK -0313B

APPLICATION			
HONDA	Pioneer 1000 SXS (2 Seater)	R Left	16-21
HONDA	Pioneer 1000 SXS (4 Seater)	R Left	16-21
HONDA	Talon 1000 R	R	19-21
HONDA	Talon 1000 X	R	19-21
HONDA	Talon 1000 X-4	R	19-21

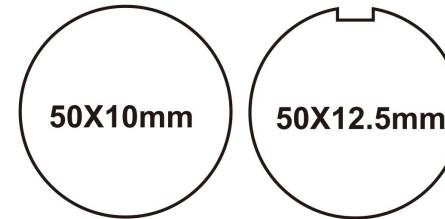

RMO-0320

APPLICATION			
KAWASAKI	HI-D/E/F 500 73-75 F	F	
KAWASAKI	H2/H20A Mach IV (750cc)	F	72-73
KAWASAKI	H2-B/H2-C Mach IV (750cc)	F	74-75
KAWASAKI	Z 900 Z1A/Z1B	F	74-76
SUZUKI	GT 185/GT 250/GT 380 L/M/A/B	F	74-79
SUZUKI	RE5 M/A	F	75-77
SUZUKI	GT 550/750 K/L/M/A/B 73-77 F	F	73-77



RMO-0315

APPLICATION			
YAMAHA	S3		

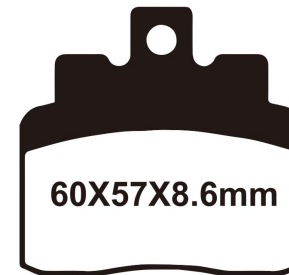

RMO-0321

APPLICATION			
BENDA MOTOR	BD300-15	F	15

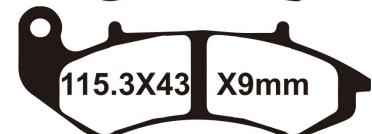
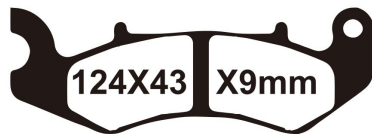

RMO-0316

APPLICATION			
BENELLI	TNT 125 (Tornado Naked T 125cc)	F	17-21
BENELLI	TNT 125 (Tornado Naked T 125cc)	F	18
BENELLI	Worx 125	F	17-18
BENELLI	BN125	F	18-21

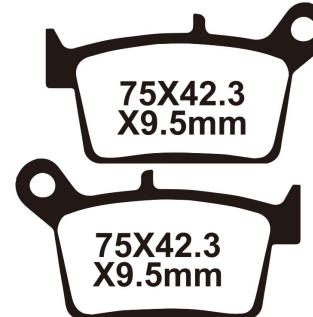

RMK -0322

APPLICATION			
HONDA	GL 1800 B Goldwing J (Manual)	F	18-20
HONDA	GL 1800 Goldwing Tour J (Manual)	F	18-20
HONDA	GL 1800 BD Goldwing J (DCT)	F	18-20
HONDA	GL 1800 D Goldwing Tour J (DCT)	F	18-20
HONDA	GL 1800 DA Goldwing Tour Airbag J (DCT)	F	18-20

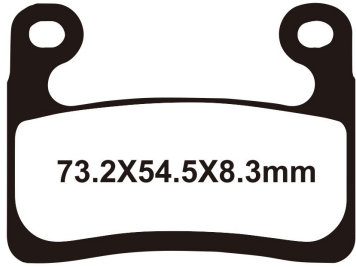

73.2X54.5X8.3mm

RMK -0323

APPLICATION

--	--	--	--

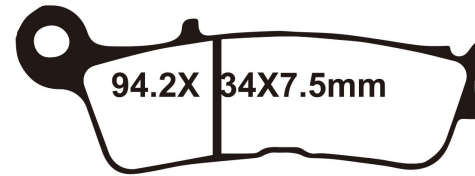

94.2X 34X7.5mm

RMK -0329

APPLICATION

BENDA MOTOR	BD300-15	F	15
-------------	----------	---	----



129.5X40X9mm

RMK -0325

APPLICATION

--	--	--	--

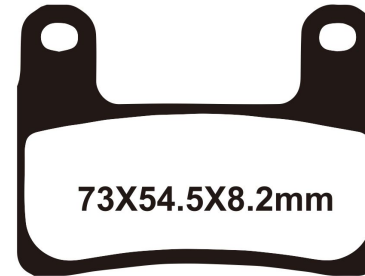

73X54.5X8.2mm

RMK -0330

APPLICATION

--	--	--	--

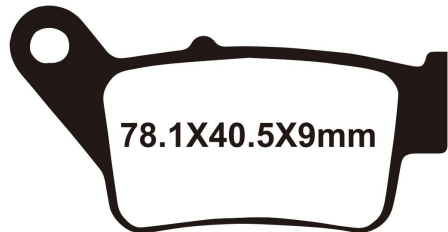

78.1X40.5X9mm

RMK -0327

APPLICATION

--	--	--	--



88.7X37X10.7mm

RMK -0337

APPLICATION

BENDA MOTOR	BD300-15	F	15
-------------	----------	---	----



47X37X7mm

RMK -0328

APPLICATION

--	--	--	--

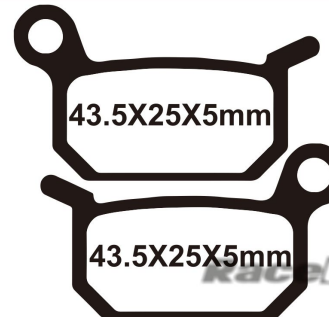

43.5X25X5mm

43.5X25X5mm

RMK -01017

APPLICATION

KTM	50 SX Mini	F Left	09-16
KTM	50 SX Pro Senior LC	F Left	04-16
KTM	50 SX Pro Senior LC	R Left	04-16
KTM	50 SX Pro Senior LC	F Left	02-07
KTM	50 Senior Adventure	F Left	02-07
KTM	65 SX	R Left	04-08
KTM	65 XC	R Left	08

ORGANIC

Material: Semi-metallic

Features: Yongli's basic selection , significantly improved compared with the original brake effect

Application: Scooter,normal motorcycle,electric scooter



Material: Semi-metálico

Características: significativamente melhorado em comparação com o efeito de travagem original

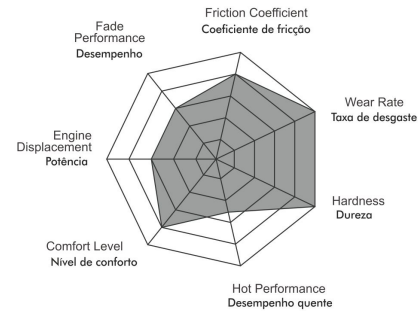

SINTERED

Material: sintered

Features: New formula of nickel free and lead free, excellent braking force and low abrasion in extremely high temperature braking environment

Application: Off road, modified motobikes, competitive version bike, large displacement recreational vehicle



Material: Sinterizado

Características: Nova fórmula livre de níquel e chumbo, adaptável a altas temperaturas excelente força de travagem e baixa abrasão em temperatura extremamente alta

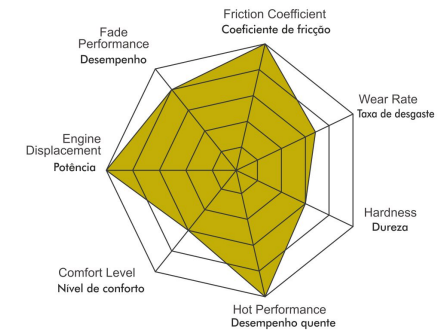

KEVLAR COMP

Material: less metallic , including Dupont Kevlar fiber

Features: Excellent brake sensitivity, long service life, adapt to high temperature brake environment

Application: Kart, ADV cross-country bike, heavy bike (large displacement), racing bike, modified motobikes



Material: menos metálico, inclui fibra Kevlar Dupont

Características: Excelente sensação travagem, vida útil longa, adaptável a altas temperaturas travagem

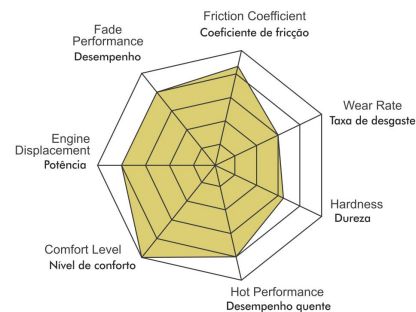

QUALITY CONTROL

Raw material test and inspections

Strict control for manufacturing process and product inspections

ISO9001, ISO14001, ISO45001

Tubo Travão							
Comprimento	Código	Tubo	Porcas	Comprimento	Código	Tubo	Porcas
400mm	800.0400R	Preto	Vermelhas	400mm	800.0400R	Preto	Pretas
500mm	800.0500R	Preto	Vermelhas	500mm	800.0500R	Preto	Pretas
600mm	800.0600R	Preto	Vermelhas	600mm	800.0600R	Preto	Pretas
700mm	800.0700R	Preto	Vermelhas	700mm	800.0700R	Preto	Pretas
800mm	800.0800R	Preto	Vermelhas	800mm	800.0800R	Preto	Pretas
900mm	800.0900R	Preto	Vermelhas	900mm	800.0900R	Preto	Pretas
1000mm	800.1000R	Preto	Vermelhas	1000mm	800.1000R	Preto	Pretas
1100mm	800.1100R	Preto	Vermelhas	1100mm	800.1100R	Preto	Pretas
1200mm	800.1200R	Preto	Vermelhas	1200mm	800.1200R	Preto	Pretas
1300mm	800.1300R	Preto	Vermelhas	1300mm	800.1300R	Preto	Pretas
1500mm	800.1500R	Preto	Vermelhas	1500mm	800.1500R	Preto	Pretas



800.0021

Parafuso banjo M10x1.0



800.0022

Parafuso banjo M10x1.25



800.0000

Banjo 0° Preto



800.0001

Banjo 28° Preto



800.0002

Banjo 90° Vertical Preto









800.0003

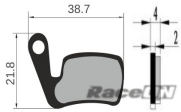
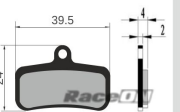
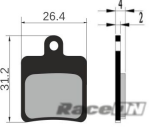
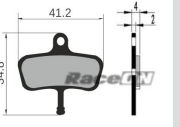
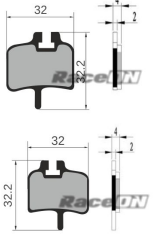
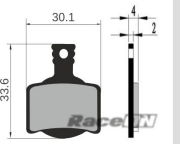
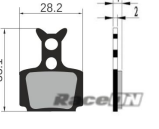
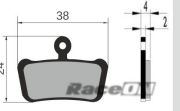
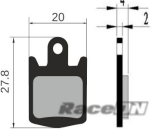
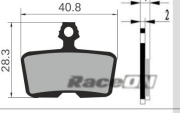
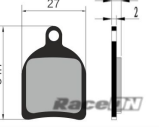
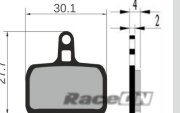

Banjo 90° Lateral Preto

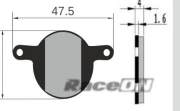
BRAKE PADS CATALOGUE

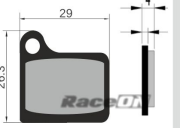

RaceON					RaceON				
MODEL MODELO	PICTURE IMAGEM	SIZE TAMANHO	BRAND MARCA	APPLICATION APLICAÇÃO	MODEL MODELO	PICTURE IMAGEM	SIZE TAMANHO	BRAND MARCA	APPLICATION APLICAÇÃO
RBK-1001		30.5*35*4	SHIMANO	M315;M355;M365;M375;M395;M4050;M416;M445/446/447;M485;M486;M505;M515;M525;M575;MT200	RBK-1018		24*37*4	AVID	BB5 (Ball Bearing 5)
			TEKTRO	HD-M282;HD-M285/286;HD-M290/291;HD-M330;HD-M352;HD-M500/501;HD-M510;HD-M520/521;MD-M280;MD-M300;MD-M500;MD-C400;MD-C500;MD-C510;MD-C601 Auriga /Draco/HDC 300					
RBK-1006		39.5*23.5*4	MAGURA	MARTA 2009-/LOUISE 2007-/JULIE HP	RBK-1019		31.9*35*4	AVID	Hydraulic Juicy 5 and 7, BB7
RBK-1009		20.8*27.4*4	PROMAX	DSK-810	RBK-1021		29.7*33.1*4	SRAM	Level TL, T, DB5, DB3, Db1
			HAYES	MX 2;Sole;MX3;MX4;MX5;CX5				AVID	Elixir R, CR, CR Mag, 1, 3, 5, 7, 9, X.0, XX, World Cup
			BENGAL	HELI X3;X5					
RBK-1010		37*26.8*4	SHIMANO	XT M775, M775-DH	RBK-1025		22.8*28.8*4	HAYES	MX2/MX3/SOLE
				XTR Pre-02, Grimeca System 8, Hope M4, Sram 9.0				JAK	JAK-5;B777
RBK-1012		42.9*24.8*4	MAGURA	LOUISE FR/LOUISE 2002-2006/CLARA 2001-2002	RBK-1026		23*34*4	TEKTRO	LYRA&IOX NOVELA 2011
RBK-1015		34.3*26.7*4	SHIMANO	Deore LX BR-M655;Deore XT BR-M755;Deore LX BR-M765;Deore LX BR-M775;Deore XT BR-M965;Deore XT BR-M966;Deore XT BR-M975;Saint XT (04-07;XTR (03-07);Saint M800;Deore LX'05;M505;M535;M545;M585;M595;M596;M601;M615;M665;M765;M775;M800;M965;M966;M975	RBK-1027		27.1*33.6*4	FORMULA	Oro Hydraulic
				ZOOM				HB-870	GIANT
RBK-1016		32*29.8*4	SHIMANO	XTR 2011, M985	RBK-1028		27*31.2*4	HOPE	MOTO V2
RBK-1017		43.5*25*5	FORMULA	4 Racing /B4	RBK-1029		27*26.5*4	HAYES	Prime Comp;Stroker Ryde Dyon Sport
				2-piston B4,4-piston '02					

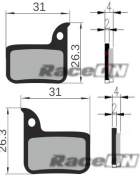
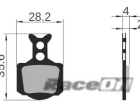
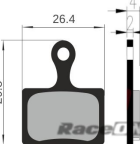
RaceON					RaceON				
MODEL MODELO	PICTURE IMAGEM	SIZE TAMANHO	BRAND MARCA	APPLICATION APLICAÇÃO	MODEL MODELO	PICTURE IMAGEM	SIZE TAMANHO	BRAND MARCA	APPLICATION APLICAÇÃO
RBK-1030		38.7*21.8*4	MAGURA	Marta/ Marta SL 2002-2008	RBK-1039		39.5*24*4	SHIMANO	Saint BR- M810;M820;M640;MT420;MT520;M712 0;M8120;M9120
RBK-1031		26.4*31.2*4	HOPE	Mini	RBK-1041		41.2*34.8*4	AVID	code 2008-2010
			GIANT	DA3;DA5					
RBK-1032		32*32.2*4	HAYES	Mechanical & Hydraulic caliper	RBK-1042		30.1*33.6*4	MAGURA	MT2;MT4;MT6;MT8
			PROMAX	Mechanical & Hydraulic caliper					
			HFX	Mechanical & Hydraulic caliper					
			IMPERIAL	DX04 Hydraulic caplier					
RBK-1034		28.2*33.1*4	FORMULA	THE ONE/R1, MEGA/RX;R1;R1 RACING;RO;C1;CR3	RBK-1043		38*24*4	AVID	E7 trail;E9 trail ;XO trail;XX trail ;GUIDE
RBK-1035		20*27.8*4	HOPE	M4;Tech "4-0" Four Piston Downhill	RBK-1044		40.8*28.3*4	AVID	CODE R
			GRIMECA	System 11/47 (2 sets per caliper needed)					
RBK-1036		27*34.7*4	HOPE	MONO TRIAL	RBK-1045		30.1*27.7*4	HOPE	MONO Mini NG
RBK-1037		40.5*23*4	HOPE	XC4-Piston w/pin &spring	RBK-1047		47.5*28.7*4	MAGURA	Julie 2001-2008
				XC-4 Cross country					
RBK-1038		41.6*26.5*4	MAGURA	MARTA 2009-/LOUISE 2007-/JULIE HP	RBK-1051		29*26.3*4	SHIMANO	Deore Mechanical 2001&2002 Nexave Hydraulic
					RBK-1052		18.8*29.4*4	MAGURA	MT5/MT7

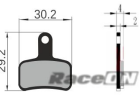
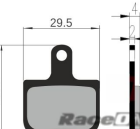
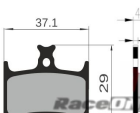
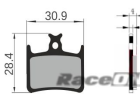
MODEL MODELO	PICTURE IMAGEM	SIZE TAMANHO	BRAND MARCA	APPLICATION APLICAÇÃO
RBK-1053		31*26.3*4	SRAM	HRD Rival Red Force S700
RBK-1054		28.2*35.6*4	FORMULA	The One, R1, RX, RO, T1, C1
RBK-1055		26.4*29.8*4	SHIMANO	XTR;M615;M666;M675;M785;M985;M988;M6000;M7000;M8000;M8020;M9000;M9020;R315;R515;S700;RS785;R785;CX75 SHIMANO ROAD
RBK-1056		43.2*27.9*4	MAGURA	MT5 /MT7/SH901
RBK-1057		22.4*33.5*4		Mechanical Brake
RBK-1058		30*29.3*4		RaceON MX One
RBK-1060		29.5*30.5*4	SRAM	LEVEL T
RBK-1061		37.1*29*4	HOPE	E4
RBK-1062		30.9*28.4*4	HOPE	RX4

KEVLAR COMP

Material: less metallic , including Dupont Kevlar fiber

Features: Excellent brake sensitivity, long service life, adapt to high temperature brake environment

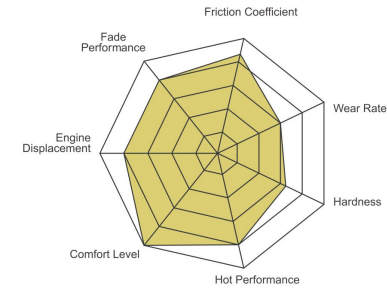

ENG

KEVLAR COMP

Material: menos metálico, inclui fibra Kevlar Dupont

Características: Excelente sensação travagem, vida útil longa, adaptável a altas temperaturas travagem

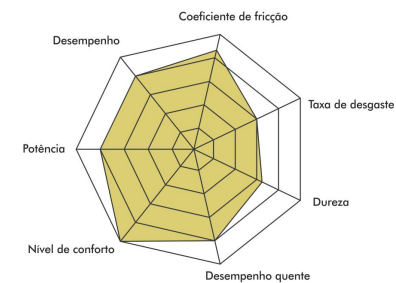

PT